



Single Phase Inverter with HD-Wave Technology and SetApp Configuration

Quick Installation Guide

P. 01 >

EN
FR
NL
IT
DE

P. 19 >











PL
ES
CHS
CHT

P. 37 >

PT
TH
CZ
SE
TR

For Europe, APAC and
South Africa
Version 1.0

EN LEGEND FR LÉGENDE NL LEGENDA IT LEGENDA DE LEGENDE

 <ul style="list-style-type: none"> EN Note FR Remarque NL Opmerking IT Nota DE Hinweis 	 <ul style="list-style-type: none"> EN Do not cut cable connectors FR Ne pas couper les connecteurs du câble NL Snijd geen connectorkabels door IT Non tagliare i connettori dei cavi DE Steckverbinder nicht abschneiden 	 <ul style="list-style-type: none"> EN <ol style="list-style-type: none"> 1. Turn ON/OFF/P Switch to OFF (0) 2. Turn Safety Switch to OFF 3. Open the six cover screws FR <ol style="list-style-type: none"> 1. Placer le commutateur MARCHE/ARRÊT sur ARRÊT (0) 2. Placer l'interrupteur de sécurité sur ARRÊT 3. Ouvrir les six vis du couvercle NL <ol style="list-style-type: none"> 1. Zet AAN/UIT schakelaar UIT (0) 2. Zet de veiligheidsschakelaar UIT 3. Open de zes dekselschroeven IT <ol style="list-style-type: none"> 1. Portare il selettore ON/OFF su OFF (0) 2. Portare l'interruttore di sicurezza su OFF 3. Aprire le sei viti del copechio DE <ol style="list-style-type: none"> 1. ON/OFF-Schalter auf OFF stellen (0) 2. DC-Trennschalter auf OFF stellen 3. Sechs Gehäuseschrauben lösen
 <ul style="list-style-type: none"> EN Turn ON/OFF the main circuit board AC switch FR Allumer/Éteindre le commutateur AC du circuit intégré principal  <ul style="list-style-type: none"> NL Schakel de AC-schakelaar op PCB AAN/UIT IT Chiudere/aprire (ON/OFF) il sezionatore CA principale DE Trennschalter im AC-Stromkreisverteiler EIN-oder AUS schalten 	 <ul style="list-style-type: none"> EN Inverter ON/OFF Switch: 0=OFF; 1=ON; P=Pairing/Program FR Interrupteur MARCHE/ARRÊT MARCHE = 1 ARRÊT = 0 P = Appairage NL Omvormer AAN/UIT; Schakelaar: 0=UIT; 1=AAN; P=Koppelen/Programmeren IT Selettore ON/OFF dell'inverter 0=OFF 1=ON P=Accoppiamento DE ON/OFF-Schalter des Wechselrichters: 0=OFF; 1=ON; P= Kopplung 	
 <ul style="list-style-type: none"> EN Torque value FR La valeur du couple NL Draaimomentwaarde IT Valore di coppia DE Drehmomentwert 	 <ul style="list-style-type: none"> EN Safety Switch (on optional DC Safety Unit) FR Interrupteur de sécurité (sur l'unité de sécurité DC en option) NL Veiligheidsschakelaar (op de optionele DC-veiligheidsunit) IT Interruttore di sicurezza (sull'unità di sicurezza CC opzionale) DE DC-Trennschalter (bei optionaler DC-Sicherheitseinheit) 	 <p>9.0 N*m / 6.6 ft.*lb</p> 
 <ul style="list-style-type: none"> EN LEDs FR LED NL Leds IT LED DE LEDs 		<ul style="list-style-type: none"> EN Close the six cover screws FR Fermer les 6 vis du couvercle NL Sluit de zes dekselschroeven IT Chiudere le sei viti del coperchio DE Sechs Gehäuseschrauben anziehen

1

- EN INSTALLING THE POWER OPTIMIZERS
- FR INSTALLATION DES OPTIMISEURS DE PUISSANCE
- NL MONTAGE VAN DE POWER OPTIMIZERS
- IT INSTALLAZIONE DEGLI OOTTIMIZZATORI DI POTENZA
- DE INSTALLIEREN DER LEISTUNGSOPTIMIERER

- 1
- 2
- 3
- 4
- 5

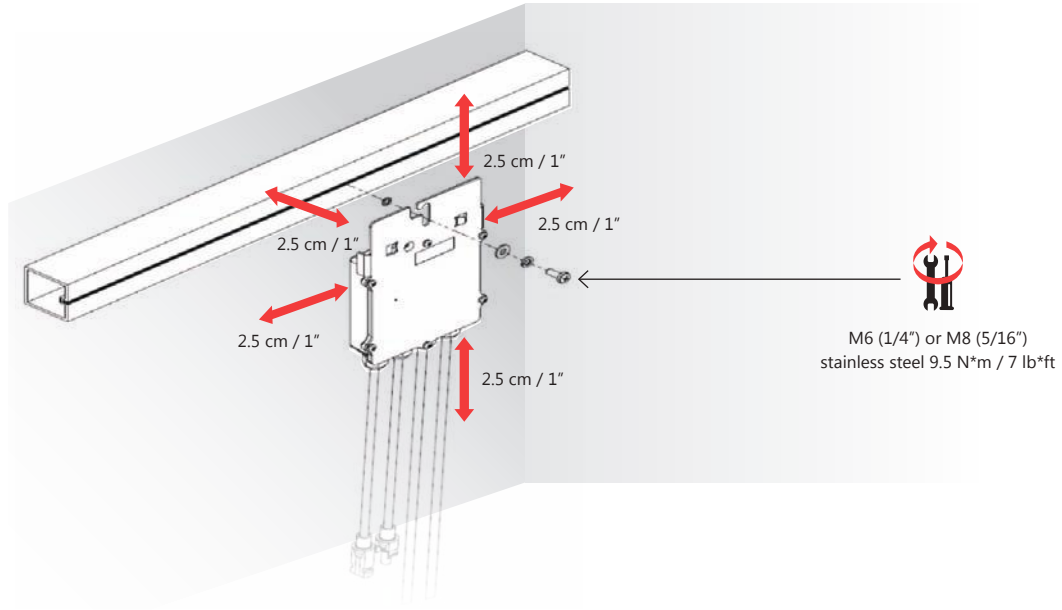

1

1 2 3 4 5

EN OPTION A NL OPTIE A DE OPTION A
FR OPTION A IT OPZIONE A

EN Peel off stickers
FR Autocollants détachables
NL Verwijder de stickers
IT Staccare le etichette
DE Sticker mit QR Code abziehen

EN Scan sticker sheet
FR Scanner la feuille d'autocollants
NL Scan het stickervel
IT Scansionare il foglio con le etichette
DE Anlagenlayout (gesammelte QR-Codes) scannen

EN Email to SolarEdge support
FR Envoyer le scan à l'assistance de SolarEdge
NL Stuur de scan naar SolarEdge support
IT Invia la scansione al Servizio Assistenza SolarEdge
DE E-Mail an SolarEdge-Support senden



<http://www.solaredge.com/files/pdfs/physical-layout-template.pdf>

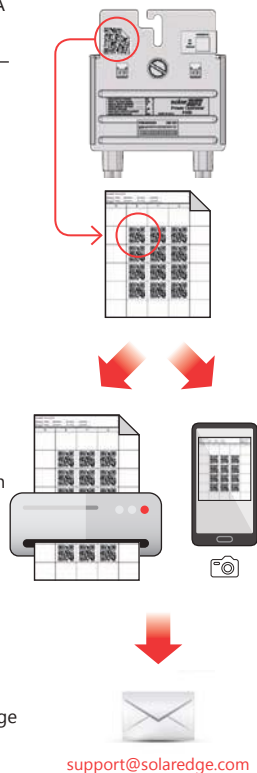

EN OPTION B NL OPTIE B DE OPTION B
FR OPTION B IT OPZIONE B

EN Scan stickers using Mapper
FR Scanner les autocollants à l'aide du Site mapper de SolarEdge
NL Scan de stickers met gebruik van de Mapper
IT Scansionare le etichette utilizzando Mapper
DE Aufkleber mithilfe der Mapper App scannen

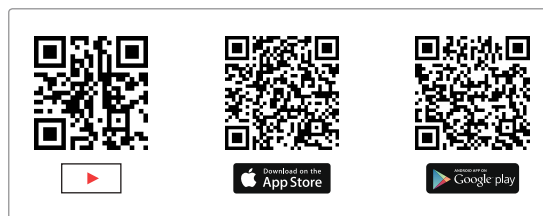

EN Complete site registration and physical layout in the monitoring platform
FR Compléter l'enregistrement du site et la disposition physique sur la plateforme de supervision
NL Volledige siteregistratie en fysieke opmaak in het monitoring platform
IT Completare la registrazione ed il layout fisico dell'impianto nella piattaforma di monitoraggio
DE Registrierung der Anlage und physikalisches Layout in der Monitoring-Plattform abschließen

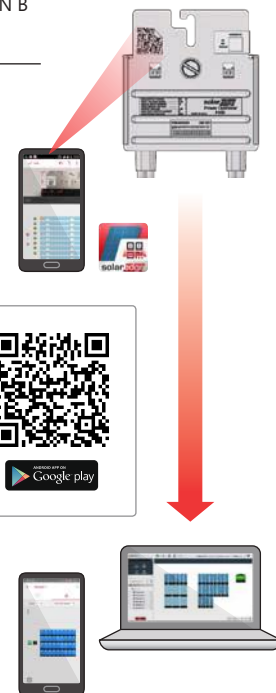

1

1 2 3 4 5

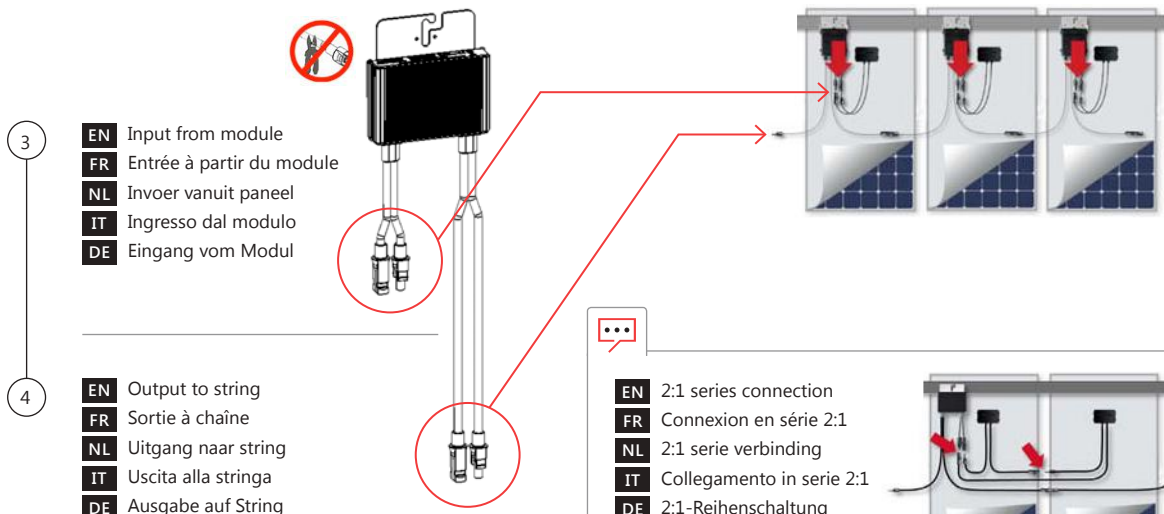

EN Extension cables (4mm²/11 AWG) between optimizers are allowed between rows and around obstacles

FR Les rallonges (11 AWG / 4 mm²) entre optimiseurs sont autorisés entre les rangées et autour des obstacles

NL Verlengkabels (4 mm²) tussen de optimizers zijn toegestaan tussen de rijen en rond obstakels

IT Fra gli ottimizzatori possono essere utilizzati cavi di prolunga (11 AWG/4mm²) tra le righe e attorno agli ostacoli

DE Verlängerungskabel (11 AWG/4 mm²) zwischen den Optimizern sind zwischen den Reihen und um Hindernisse herum zulässig

EN For 2:1 parallel connection the P405 has dual input. For other optimizers use a branch cable

FR Pour une connexion en parallèle 2:1, le P405 possède une double entrée. Pour d'autres optimiseurs, utiliser un câble de branchement

NL Voor een 2:1 parallelschakeling heeft de P405 een dubbele invoer. Gebruik voor andere optimizers een aftak kabel

IT Per il collegamento in parallelo 2:1, il P405 dispone di un doppio ingresso. Per altri ottimizzatori utilizza un cavo di derivazione

DE Für die 2:1-Parallelschaltung verfügt der Leistungsoptimierer P405 über einen Dual-Eingang. Für andere Leistungsoptimierer ist ein Adapterkabel zu verwenden

1

1 2 3 4 5

EN Check string polarity and measure each string's voltage to verify $1\pm 0.1V$ per optimizer

FR Vérifier la polarité de la chaîne et mesurer chaque tension sur chaîne pour vérifier la tension de $1\pm 0.1V$ par optimiseur

NL Controleer de polariteit van de string en meet de spanning van elke string om de $1\pm 0.1V$ per optimizer te verifiëren

IT Controllare la polarità delle stringhe e misurare la tensione di ciascuna stringa per verificare la presenza di $1\pm 0.1 V$ per ogni ottimizzatore

DE Prüfen Sie die Strang-Polarität und messen Sie die Spannung jedes Stranges, um $1\pm 0.1 V$ pro Optimierer zu bestätigen

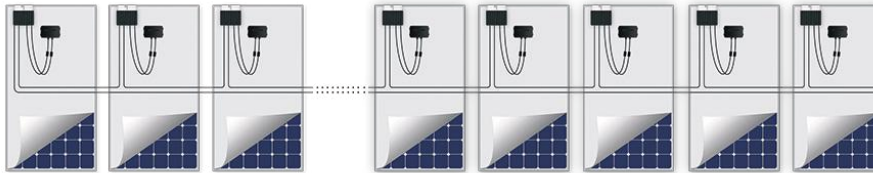

EN Example: 16 optimizers = ~16V

FR Exemple: 16 optimiseurs = ~16V

NL Voorbeeld: 16 optimizers = ~ 16V

IT Esempio: 16 ottimizzatori di potenza ~ 16V

DE iel: 16 Leistungsoptimierer = ~16V

2

- EN INSTALLING THE INVERTER
- FR INSTALLATION DE L'ONDULEUR
- NL MONTAGE VAN DE OMVORMER
- IT INSTALLAZIONE DELL'INVERTER
- DE INSTALLIEREN DES WECHSELRICHTERS

1 2 3 4

1 2 3 4

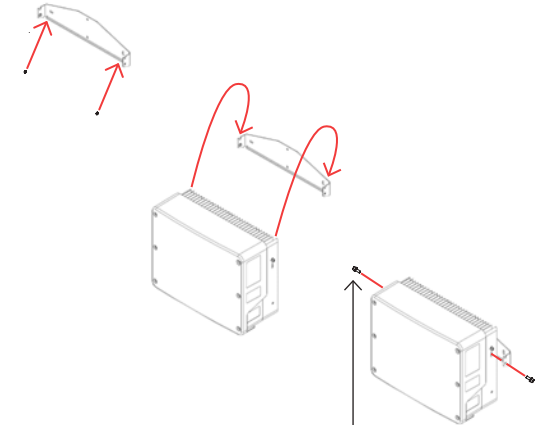
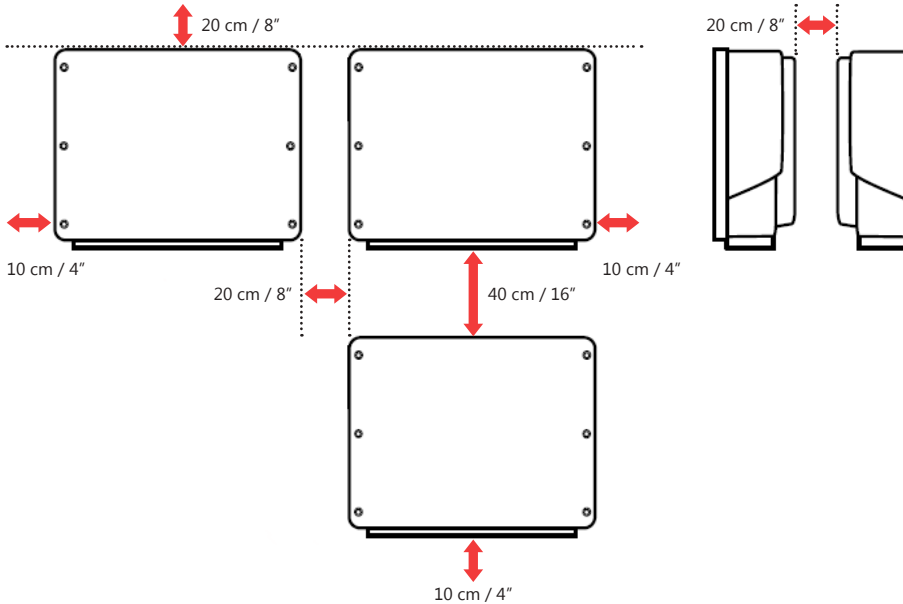

4.0 N*m / 2.9 lb.*ft.

3

- EN CONNECTING THE STRINGS TO THE INVERTER
- FR CONNEXION DES CHAÎNES À L'ONDULEUR
- NL VERBINDEN VAN DE STRINGS MET DE OMVORMER
- IT COLLEGAMENTO DELLE STRINGHE ALL'INVERTER
- DE ANSCHLIEßEN DIE STRINGS UM DEN WECHSELRICHTER

1 2

1

- EN 1-3 MC4 pairs, model dependent
- FR 1-3 paires MC4, modèle dépendant
- NL 1-3 MC4-paar, afhankelijk van het
- IT 1-3 coppie MC4, in base al m
- DE 1-3 MC4 Paare, je nach Modell



- EN For additional strings in parallel use external combiner box or branch cable
- FR Pour des chaînes supplémentaires en parallèle, utilisez un coffret de raccordement ou un Y
- NL Gebruik voor parallelle strings een externe verbindingskast of een aftakingskabel
- IT Per stringhe aggiuntive in parallelo, utilizza un quadro di parallelo esterno o dei cavi di derivazione
- DE Für zusätzliche parallele Stränge verwenden Sie ein DC-GAK/Combiner Box oder Y-Kabel

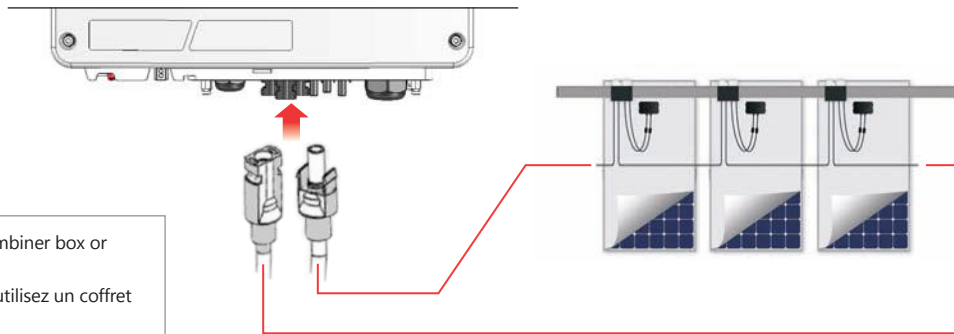

2

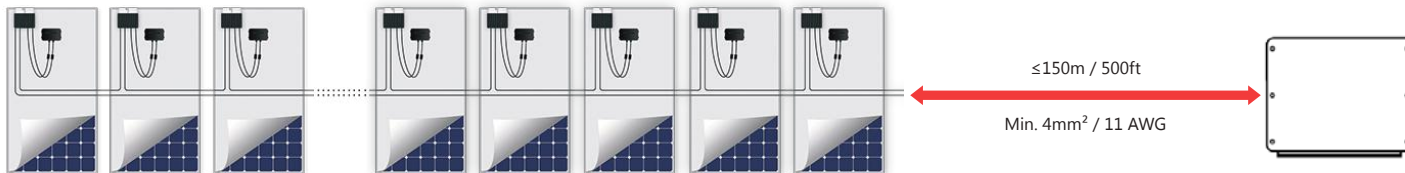

4

- EN CONNECTING THE AC TO THE INVERTER
- FR CONNEXION DU CA À L'ONDULEUR
- NL ANSLUITEN VAN AC OP DE OMVORMER
- IT COLLEGAMENTO CA DELL'INVERTER
- DE ANSCHLIEßEN DES NETZ UM DEN WECHSELRICHTER

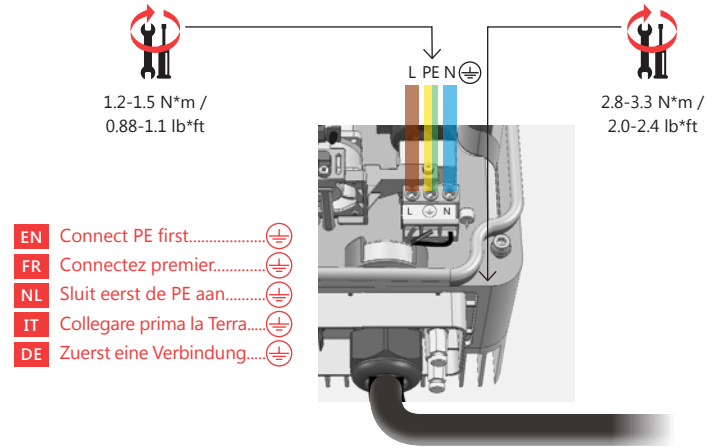
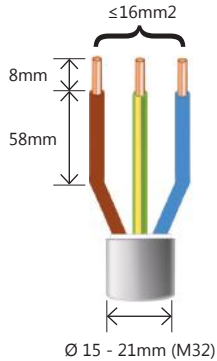







5

- EN** SETTING UP COMMUNICATION
- FR** CONFIGURATION DE LA COMMUNICATION
- NL** COMMUNICATIE INSTELLEN
- IT** IMPOSTAZIONI DI COMUNICAZIONE
- DE** EINRICHTEN DER KOMMUNIKATION



<p>EN Built-in:</p> <ol style="list-style-type: none"> 1. Ethernet p.10 2. RS485 p.10 3. Wi-Fi 	<p>FR Intégré:</p> <ol style="list-style-type: none"> 1. Ethernet p.10 2. RS485 p.10 3. Wi-Fi 	<p>NL Ingebouwd:</p> <ol style="list-style-type: none"> 1. Ethernet p.10 2. RS485 p.10 3. Wi-Fi 	<p>IT Incluso:</p> <ol style="list-style-type: none"> 1. Ethernet p.10 2. RS485 p.10 3. Wi-Fi 	<p>DE Integriert:</p> <ol style="list-style-type: none"> 1. Ethernet p.10 2. RS485 p.10 3. Wi-Fi
--	---	---	---	--

EN Optional	FR En option	NL Optioneel	IT Opzionale	DE Optional
	<p>EN ZigBee for monitoring</p>	<p>FR Zigbee pour la supervision</p>	<p>NL ZigBee voor monitoring</p>	<p>IT ZigBee per Monitoraggio</p> <p>DE ZigBee für Monitoring</p>  <p>EN</p>
	<p>EN ZigBee for Smart Energy (available in some models)</p>	<p>FR Zigbee pour la gestion de l'énergie</p>	<p>NL ZigBee voor smart energy</p>	<p>IT ZigBee per Smart Energy</p> <p>DE ZigBee für Smart Energy</p>  <p>EN</p>
	<p>EN GSM Plug-in</p>	<p>FR Plug-in GSM</p>	<p>NL GSM plug-in</p>	<p>IT Scheda GSM</p> <p>DE GSM-Modul</p>  <p>EN</p>

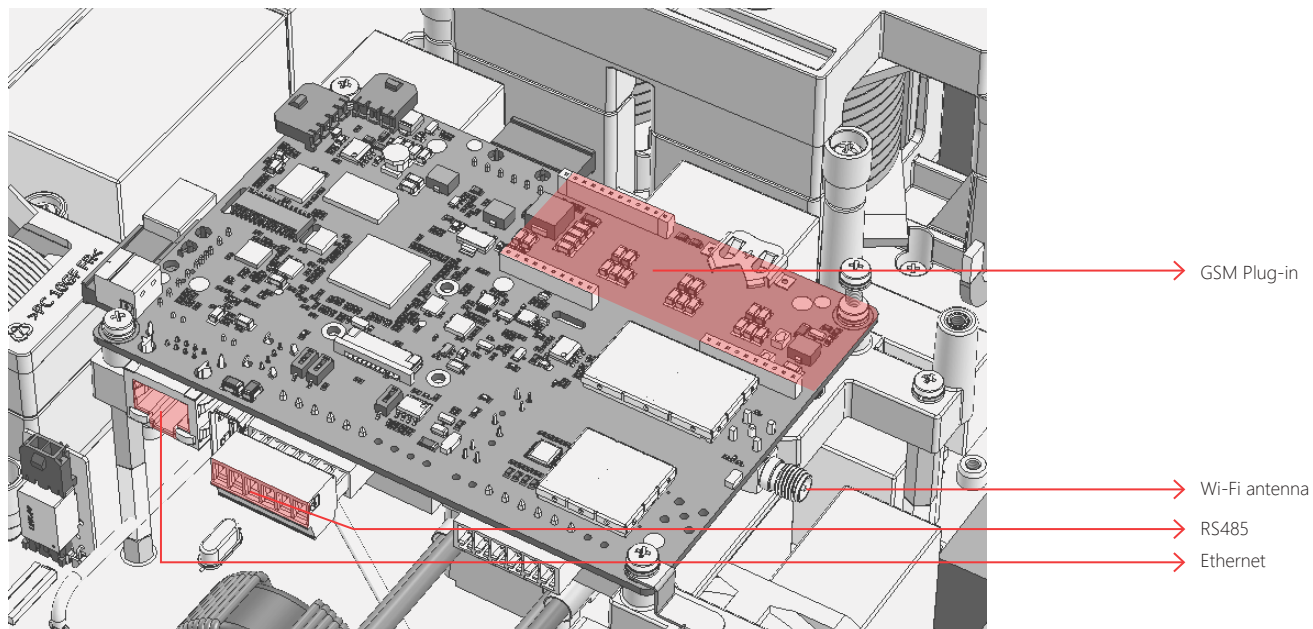

EN For troubleshooting
FR Pour le dépannage
NL Voor probleemoplossing
IT Per la risoluzione dei problemi
DE Zur Fehlersuche



EN Application note: Communication Options
FR Note d'application : Options de communication
NL Applicatie note: Communicatie opties
IT Per la risoluzione dei problemi
DE Anwendungshinweis: Kommunikationsoptionen



6

- EN CREATING AN ETHERNET (LAN) CONNECTION
 FR CRÉATION D'UN CONNEXION ETHERNET (LAN)
 NL HET MAKEN VAN EEN ETHERNET (LAN) VERBINDING
 IT CREAZIONE DI UNA CONNESSIONE ETHERNET (LAN)
 DE EINRICHTEN EINER ETHERNET-VERBINDUNG (LAN)

1 2 3 4

1

2

3

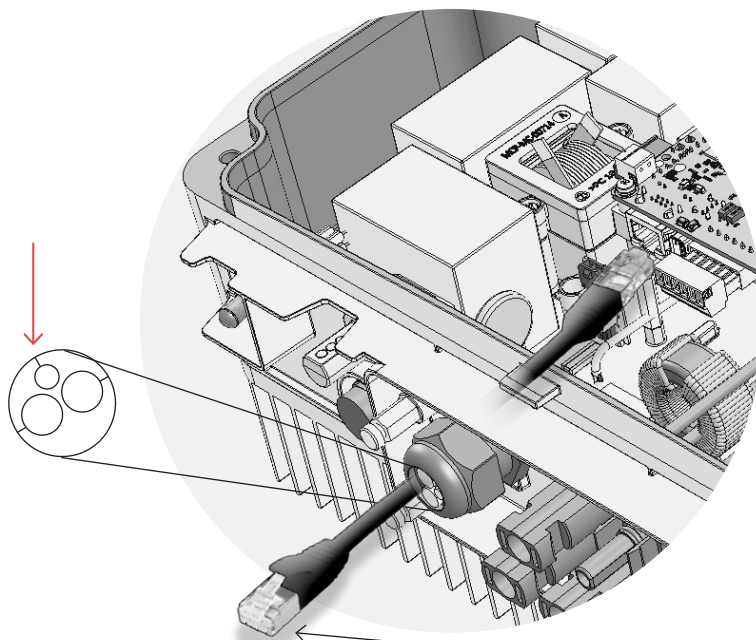
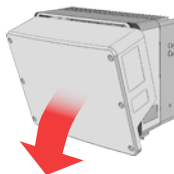

- EN Ethernet Router
 FR Routeur Ethernet
 NL Ethernet router
 IT Router Ethernet
 DE Ethernet-Router

EN

RJ45 Pin #	Wire Color ¹		10Base-T Signal 100Base-TX Signal
	T568B	T568A	
1	White/Orange	White/Green	Transmit+
2	Orange	Green	Transmit-
3	White/Green	White/Orange	Transmit+
4	Blue	Blue	Reserved
5	White/Blue	White/Blue	Reserved
6	Green	Orange	Received-
7	White/Brown	White/Brown	Reserved
8	Brown	Brown	Reserved

FR

RJ45 Pin #	Couleur de câble ¹		Signal 10Base-T Signal 100Base-TX
	T568B	T568A	
1	Blanc/Orange	Blanc/Vert	Transmission+
2	Orange	Vert	Transmission-
3	Blanc/Vert	Blanc/Orange	Transmission+
4	Bleu	Bleu	Réservé
5	Blanc/Bleu	Blanc/Bleu	Réservé
6	Vert	Orange	Réceptionné-
7	Blanc/Brun	Blanc/Brun	Réservé
8	Brun	Brun	Réservé

NL

RJ45- pin- nummer	Kleur van de draden ¹		10Base-T signaal 100Base-TX signaal
	T568B	T568A	
1	Wit/Oranje	Wit/Groen	Transmit+
2	Oranje	Groen	Transmit-
3	Wit/Groen	Wit/Oranje	Transmit+
4	Blauw	Blauw	Gereserveerd
5	Wit/Blauw	Wit/Blauw	Gereserveerd
6	Groen	Oranje	Received-
7	Wit/Bruin	Wit/Bruin	Gereserveerd
8	Bruin	Bruin	Gereserveerd

IT

N. di pin del RJ45	Colore del filo ¹		Segnale 10Base-T Segnale 100Base-TX
	T568B	T568A	
1	Bianco/Arancione	Bianco/Verde	Trasmissione+
2	Arancione	Verde	Trasmissione-
3	Bianco/Verde	Bianco/Arancione	Trasmissione+
4	Blu	Blu	Riservato
5	Bianco/Blu	Bianco/Blu	Riservato
6	Verde	Arancione	Ricezione-
7	Bianco/Marrone	Bianco/Marrone	Riservato
8	Marrone	Marrone	Riservato

DE

RJ45- Kontakt- Nr.	Drahtfarbe ¹		10Base-T Signal 100Base-TX Signal
	T568B	T568A	
1	Weiß/Orange	Weiß/Grün	Senden+
2	Orange	Grün	Senden-
3	Weiß/Grün	Weiß/Orange	Empfangen+
4	Blau	Blau	Reserviert
5	Weiß/Blau	Weiß/Blau	Reserviert
6	Grün	Orange	Empfangen-
7	Weiß/Braun	Weiß/Braun	Reserviert
8	Braun	Braun	Reserviert

EN ¹ The inverter connection does not support RX/TX polarity change. Supporting crossover Ethernet cables depends on the switch capabilities

FR ¹ La connexion de l'onduleur ne prend pas en charge le changement de polarité RX/TX. La prise en charge des câbles Ethernet croisés dépend du router/modem

NL ¹ De omvormer verbinding ondersteunt geen RX/TX polariteit veranderingen. Ondersteunen van cross-over ethernet kabels is afhankelijk van de schakelmogelijkheden

IT ¹ La connessione dell'inverter non supporta il cambio di polarità RX/TX. Il supporto di cavi Ethernet incrociati dipende dalle capacità dello switch di rete

DE ¹ Der Wechselrichteranschluss unterstützt keine RX/TX-Polaritätsänderung. Die Unterstützung von Crossover-Ethernet-Kabeln hängt davon ab ob dies von Switch/Router unterstützt wird

7

- EN** CREATING AN RS485 BUS CONNECTION
- FR** CRÉATION D'UNE CONNEXION BUS RS485
- NL** RS-485 BUS VERBINDING
- IT** CREAZIONE DI UNA CONNESSIONE SU BUS RS485
- DE** CREATING AN RS485 BUS CONNECTION

1 2

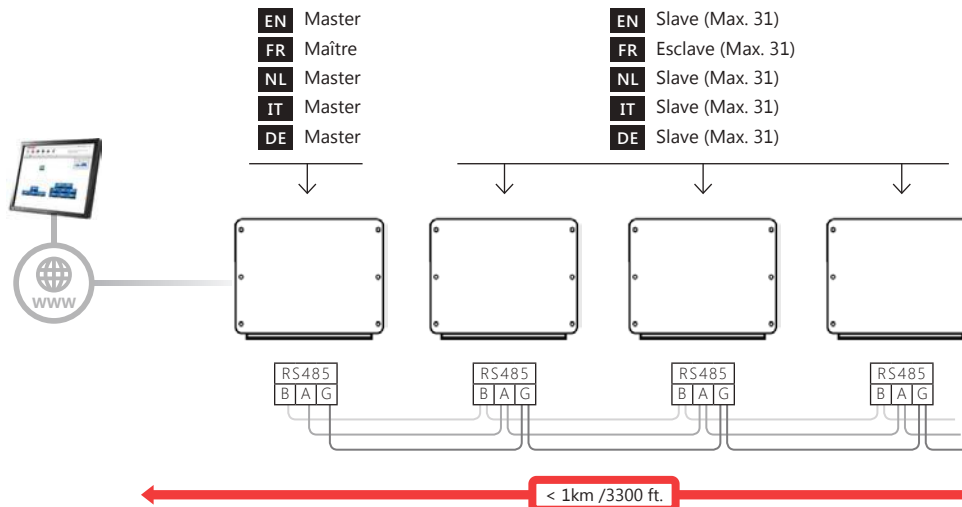

EN Min. 3-wire shielded twisted pair (a 4-wire cable may be used). Wire cross-section: 0.2-1 mm² / 24-18 AWG (a CAT5 cable may be used)

FR Min. paire torsadée blindée de 3 fils (un câble de 4 fils peut être utilisé). Section transversale du câble : 0,2-1 mm² / 24-18 AWG (un câble CAT5 peut être utilisé)

NL Minimaal 3-aderige afgeschermdde twisted-pair kabel (een 4-aderige kabel kan ook worden gebruikt). Draaddoorsnede: 0,2-1 mm² (een CAT5-kabel kan worden gebruikt)

IT Doppino intrecciato schermato con 3 fili minimo (è possibile utilizzare un cavo a 4 fili) Sezione del cavo: 0,2-1 mm² / 24-18 AWG (è possibile utilizzare un cavo CAT5)

DE Min. CAT5 - 3-adrig geschirmtes Twisted Pair Kabel (es kann ein 4-adriges Kabel verwendet werden). Aderquerschnitt: 0,2-1 mm² / 24-18 AWG (es kann ein CAT5-Kabel verwendet werden)

- EN** Terminate first and last devices: Move up SW1 DIP switch (left switch)
- FR** Terminaison du premier et dernier périphérique : passer le commutateur SW1 DIP (commutateur de gauche)
- NL** Schakel de eerste en de laatste units uit: schuif SW1 DIP-schakelaar naar boven (linker schakelaar)
- IT** Termina il primo e l'ultimo dispositivo: Sposta verso l'alto l'interruttore DIP SW1 (interruttore a sinistra)
- DE** Erstes und letztes Gerät terminieren: SW1-DIP-Schalter nach oben schieben (linker Schalter)

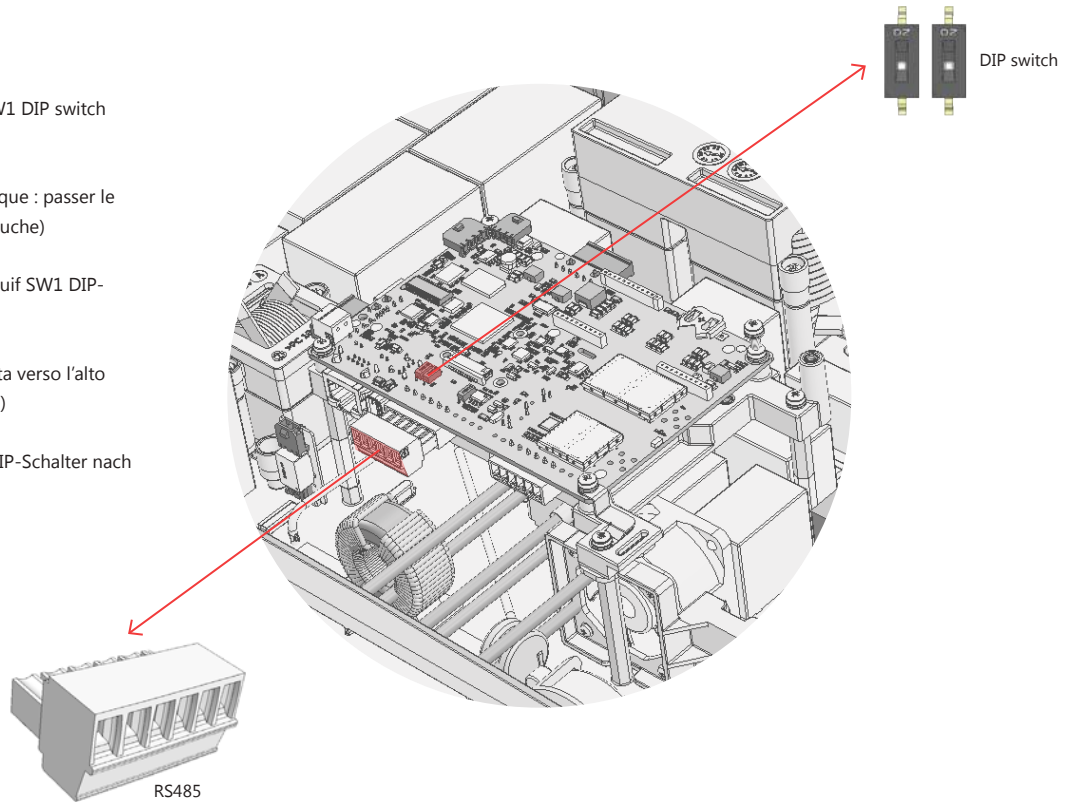



- EN 1ST TIME SETAPP INSTALLATION
- FR 1ERE INSTALLATION SETAPP
- NL EERSTE SETAPP INSTALLATIE
- IT PRIMA INSTALLAZIONE DI SETAPP
- DE ERSTES MAL SETAPP INSTALLATION

1 — 2

**EN Login:**

1. Open SetApp and follow the instructions
2. Log-in with your monitoring Username and password

FR Login:

1. Ouvrir SetApp et suivre les instructions.
2. S'identifier avec votre adresse E-Mails et votre mot de passe de la supervision

NL Login:

1. Open de SetApp en volg de instructies
2. Log in met je monitoring gebruikersnaam en wachtwoord

IT Login:

1. Apri SetApp e segui le istruzioni
2. Effettua l'accesso con il tuo username e password usati per il monitoraggio

DE Login:

1. SetApp öffnen und den Anweisungen folgen
2. Melden Sie sich mit Ihrem Benutzernamen und Passwort im Monitoring an

9

EN ACTIVATING
 FR ACTIVATION
 NL ACTIVERING
 IT ATTIVAZIONE
 DE AKTIVIERUNG

1 2



EN Scan inverter QR code; for RS485 bus, scan master first

FR Scanner le QR code de l'onduleur; pour le bus RS485, scanner le maître en premier.

NL Scan de QR-code van de omvormer; scan de master-omvormer eerst i.v.m. de RS485-bus

IT Scansiona il QR code dell'inverter; per il bus RS485, scansiona prima il master

DE RS485-Bus, Scan Master zuerst

EN Follow the SetApp instructions

FR Suivre les instructions SetApp

NL Volg de SetApp instructies op het scherm

IT Segui le istruzioni di SetApp

DE Folgen Sie den SetApp Anweisungen



EN SetApp creates a Wi-Fi connection with the inverter

FR SetApp cree une connection Wifi avec l'onduleur

NL De SetApp creëert een wifi verbinding met de omvormer

IT SetApp crea una connessione Wi-Fi con l'inverter

DE SetApp erstellt eine Wi-Fi Verbindung mit dem Wechselrichter

10

- EN** COMMISSIONING
- FR** MISE EN SERVICE DE L'INSTALLATION
- NL** INGEBRUIKNAME
- IT** MESSA IN FUNZIONE
- DE** INBETRIEBNAHME

1 2 3 4



- EN** Set Country and Language
- FR** Selecteer land en taal
- NL** Set Country and Language
- IT** Imposta Paese e Lingua
- DE** Land und Sprache einstellen

- EN** Pair the power optimizers
- FR** Couplage des optimiseurs
- NL** Koppel de power optimizers
- IT** Esegui l'accoppiamento degli ottimizzatori
- DE** Leistungsoptimierer koppeln

- EN** Set communication to the monitoring platform and to the other inverters
- FR** Paramétrer la communication à la supervision et avec les autres onduleurs

NL Selecteer de communicatie methode met het monitoring platform en de andere omvormers

IT Imposta la comunicazione verso la piattaforma di monitoraggio e con gli altri inverter

DE Kommunikation zur Monitoring Plattform und zu den anderen Wechselrichtern einrichten

- EN** Set all other parameters
- FR** Paramétrer tous les autres paramètres
- NL** Stel alle andere parameters in
- IT** Imposta tutti gli altri parametri
- DE** Alle anderen Parameter einstellen

11

- EN** VIEWING SYSTEM STATUS
- FR** VOIR LE STATUT DU SYSTEME
- NL** BEKIJK DE SYSTEEMSTATUS
- IT** VISUALIZZAZIONE DELLO STATO DEL SISTEMA
- DE** SYSTEMSTATUS ANZEIGEN

i

- EN** SetApp Status screen
- FR** Ecran de Statut SetApp
- NL** SetApp statusscherm
- IT** Schermata dello Stato su SetApp
- DE** SetApp Status-Bildschirm

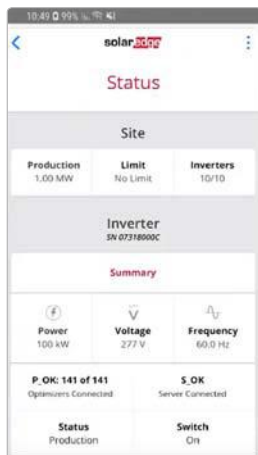



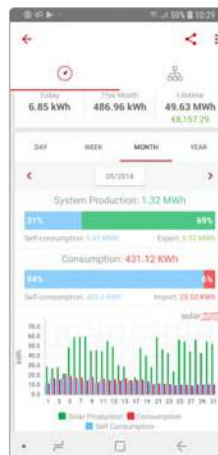



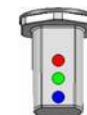

- EN** Monitoring platform
- FR** Plateforme de supervision
- NL** Monitoring platform
- IT** Piattaforma di Monitoraggio
- DE** Monitoring Plattform



- EN** Main LEDs Indications
- FR** Indications LED
- NL** Led indicaties
- IT** indicazioni tramite i LED
- DE** LED-Anzeigen

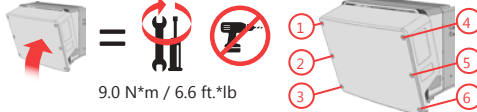

PL LEGENDA ES LEYENDA CHS LEGEND CHT LEGEND

 <p>PL Uwaga ES Nota CHS 注意 CHT 注意</p>	 <p>PL Nie wolno przecinać złączy kabla ES No cortar los cables de los conectores CHS 不要切割电缆连接器 CHT 不要切割纜連接器的線材</p>	 <p>PL 1. Wyłącz przełącznik (0) 2. Wyłącz wyłącznik bezpieczeństwa 3. Wykręć 6 śrub pokryw ES 1. Mover el interruptor ON/OFF/P en OFF (0) 2. Girar el Interruptor de Seguridad en OFF 3. Quitar los seis tornillos de la tapa CHS 1. 将开关转到关 (0) 位置 2. 将安全开关转到关位置 3. 拧开六个盖板螺丝 CHT 1. 將開關轉到關 (0) 位置 2. 將安全開關轉到關位置 3. 解開六個蓋板螺絲</p>
 <p>PL Włącz/wyłącz główny przełącznik prądu zmiennego ES Encender o Apagar el interruptor en el cuadro de CA CHS 打开/关闭主电路板交流开关 CHT 打開/關閉主電路板交流開關</p>	 <p>PL Włącznik/wyłącznik falownika: 0=WYŁ.; 1=WŁ.; P=parowanie/program ES Interruptor de ON/OFF/P del inversor: 0=Apagado; 1=Encendido; P= Emparejamiento/Programación CHS 逆变器开关: 0=关; 1=开; P=配对/编辑 CHT 逆變器開關: 0=關; 1=開</p>	
 <p>PL Moment obrotowy ES Par de apriete CHS 扭矩值 CHT 扭力值</p>	 <p>PL Wyłącznik bezpieczeństwa (na opcjonalnej jednostce bezpieczeństwa prądu stałego) ES Interruptor de Seguridad (en la caja de conexión CC opcional) CHS 安全开关 (在选配直流安全单元上) CHT 安全開關 (在選配直流安全要求上)</p>	 <p>9.0 N*m / 6.6 ft.*lb</p> <p>PL Close the six cover screws ES Fermer les 6 vis du couvercle CHS Sluit de zes dekselschroeven CHT Chiudere le sei viti del coperchio</p>
 <p>PL LEDy ES LEDs CHS LED指示灯 CHT LED指示燈</p>		

1

- PL INSTALOWANIE OPTYZMALIZATORÓW MOCY
- ES INSTALACIÓN DE LOS OPTIMIZADORES DE POTENCIA
- CHS 安裝功率优化器
- CHT 安裝功率優化器

1 2 3 4 5

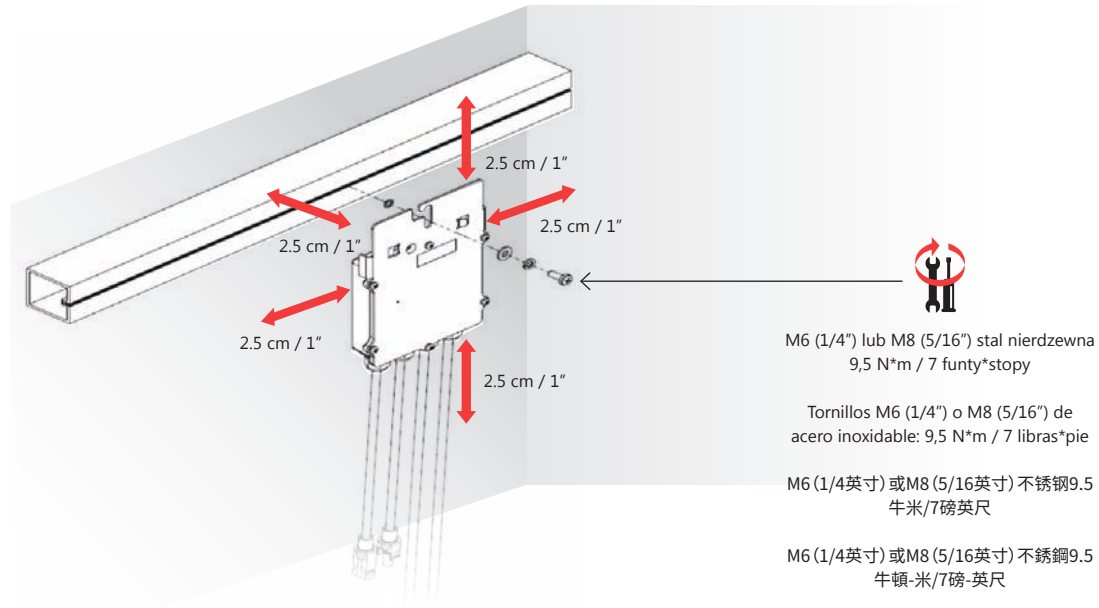

1

1 2 3 4 5

PL OPCJA A **CHS** 选项 A
 ES OPCIÓN A **CHT** 選項 A

PL Odklej naklejki
 ES Despegar las etiquetas
CHS 剥下标贴
CHT 撕下標貼

PL Zeskanuj arkusz naklejek
 ES Escanear la hoja con las etiquetas
CHS 扫描标贴单
CHT 掃描標貼單

PL Wyślij mail do wsparcia SolarEdge
 ES Enviar a la asistencia técnica de SolarEdge
CHS 发送扫描信息邮件到SOLAREEDGE支持部门
CHT EMAIL至SOLAREEDGE支援部門

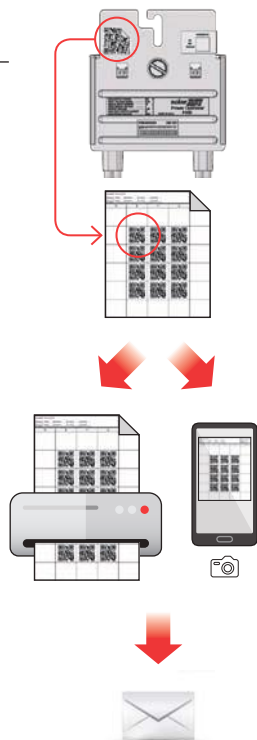

support@solaredge.com



<http://www.solaredge.com/files/pdfs/physical-layout-template.pdf>

PL OPCJA B **CHS** 选项 B
 ES OPCIÓN B **CHT** 選項 B

PL Zeskanuj naklejki za pomocą aplikacji Mapper
 ES Escanear las etiquetas utilizando el Site Mapper
CHS 使用SOLAREEDGE电站映像工具MAPPER扫描标贴
CHT 使用SITE MAPPER掃描標貼

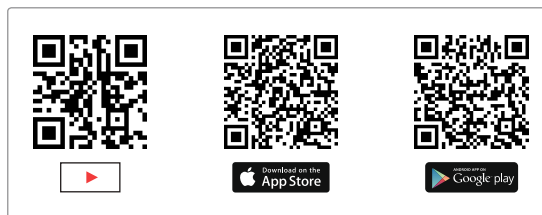

PL Wykonaj procedurę rejestracji obiektu i fizycznego rozmieszczenia na platformie monitorowania
 ES Completar el registro de la planta y el layout físico en el portal de monitorización
CHS 在监测平台上完成电站注册和物理布局图
CHT 在監控平臺上完成電站註冊和物理佈局圖

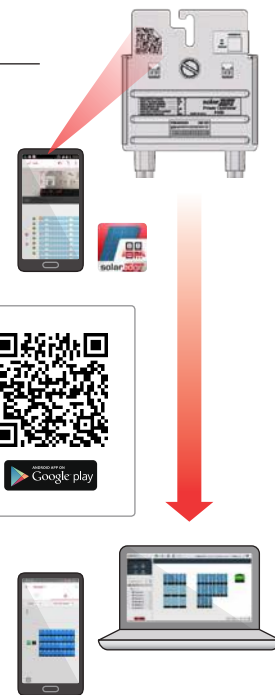

1

1 2 3 4 5

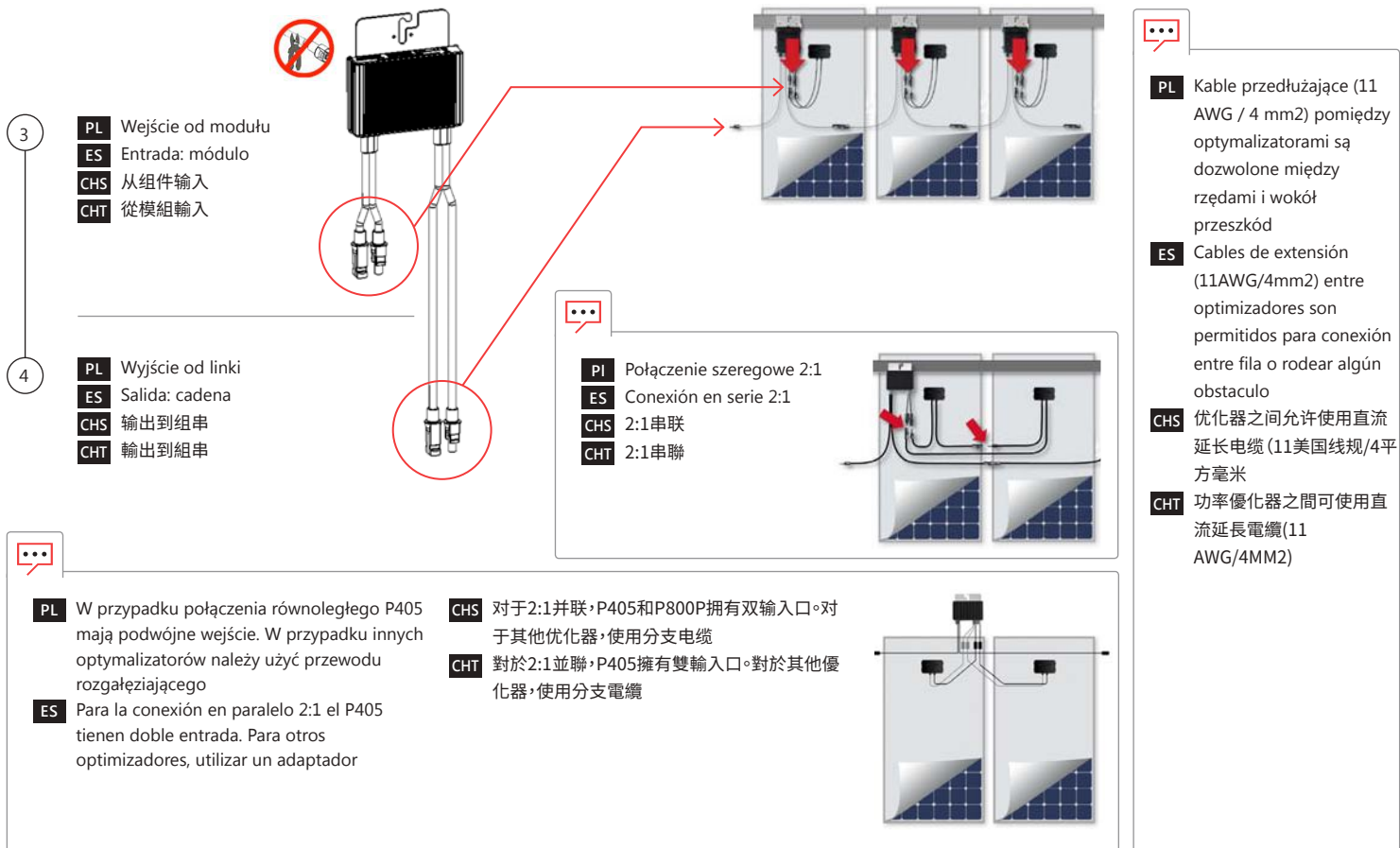

1

1 2 3 4 5

PL Sprawdź biegunowość łańcucha i zmierz napięcie każdego z nich, aby upewnić się, że wynosi $1\pm 0,1V$ na optymalizator

ES Comprobar la polaridad de la cadena y medir el voltaje de cada cadena para verificar que tenga $1\pm 0,1V$ por optimizador

CHS 检查组串极性，测量每个组串
的电压，以验证每个优化器为
1伏

CHT 检查组串极性，测量每个组串
的电压，以确认每个优化器为
1伏

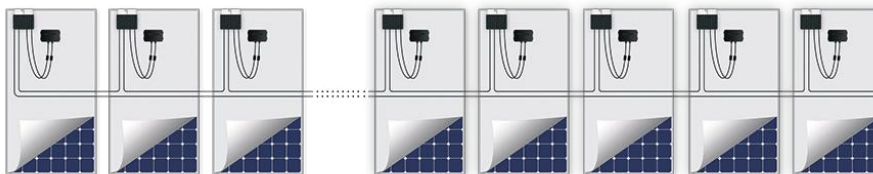

PL Przykład: 16 optymalizatorów = $\sim 16 V$

ES Ejemplo: 16 optimizadores = $\sim 16V$

CHS 例如: 16个优化器 = ~ 16 伏

CHT 例如: 16個優化器 = ~ 16 伏

2

PL INSTALOWANIE FALOWNIKA

ES INSTALAR EL INVERSOR

CHS 安裝逆變器

CHT 安裝逆變器

1 2 3 4

1 2 3 4

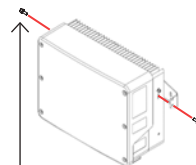
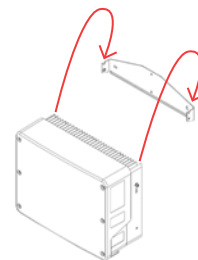
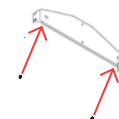
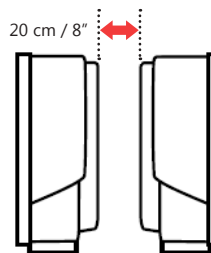
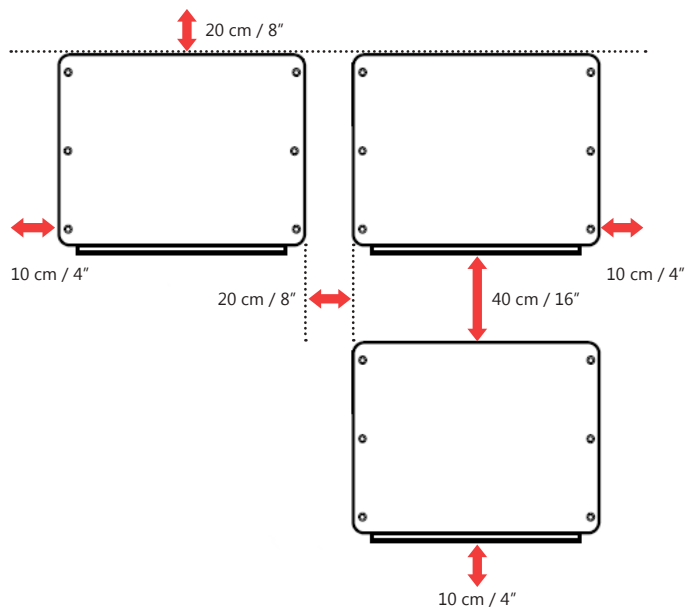

4.0 N*m / 2.9 lb.*ft.

3

- PL** PODŁĄCZANIE LINEK DO FALOWNIKA
- ES** CONECTAR LAS CADENAS AL INVERSOR
- CHS** 将组串连接到逆变器
- CHT** 將組串連接到逆變器

1 2

1

- PL** 1-3 pary MC4, w zależności od modelu
- ES** 1-3 pares de MC4, dependiendo del modelo
- CHS** 1-3對MC4接口,取決於型號
- CHT** 1-3對MC4接口,取決於型號

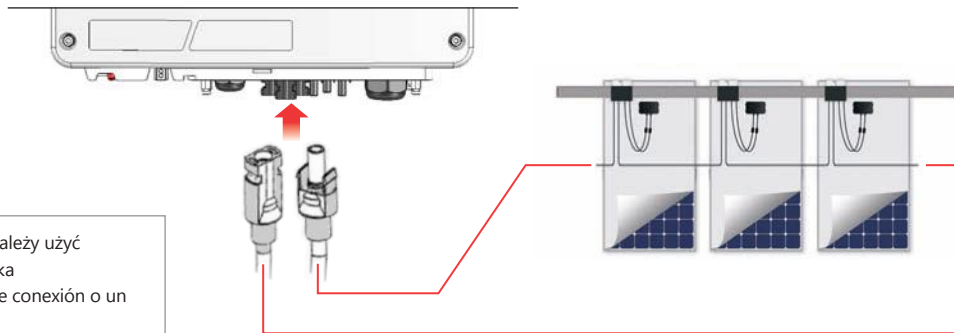

- PL** Aby uzyskać dodatkowe łańcuchy równoległe, należy użyć zewnętrznej skrzynki rozgałęznej lub rozgałęźnika
- ES** Para más cadenas en paralelo utilizar una caja de conexión o un adaptador externo
- CHS** 请使用分支电缆或者直流汇流箱来连接额外的直流组串
- CHT** 請使用分支電纜或直流匯流箱連接額外的直流組串

2

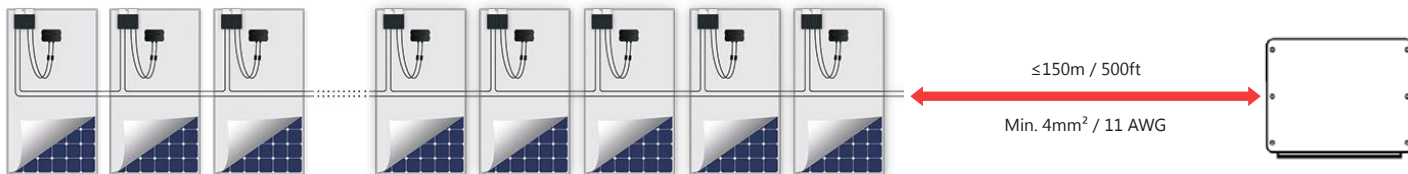

4

PL PODŁĄCZANIE ZASILANIA DO FALOWNIKA

ES CONECTAR LA CA AL INVERSOR

CHS 将交流电源连接到逆变器

CHT 將交流電源連接到逆變器

1 2 3

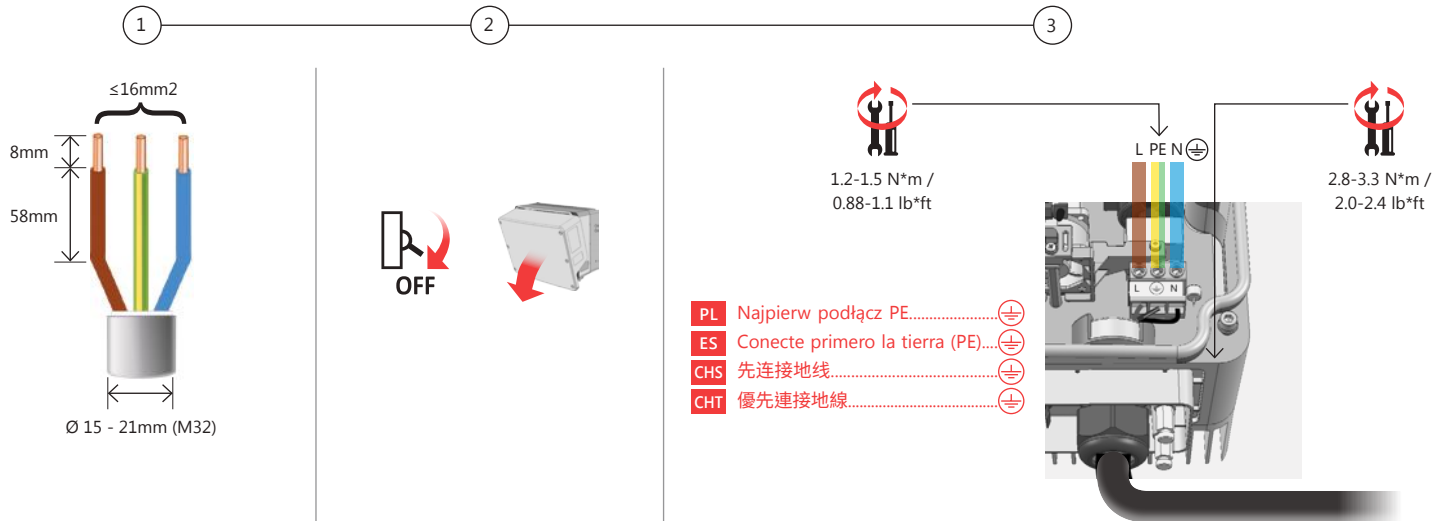



5

- PL** KONFIGUROWANIE KOMUNIKACJI
ES CONFIGURAR LA COMUNICACIÓN
CHS 设置通信
CHT 通訊設定



<p>PL Wbudowane:</p> <ol style="list-style-type: none"> 1. Ethernet p.28 2. RS485 p.28 3. Wi-Fi 	<p>ES Incorporado:</p> <ol style="list-style-type: none"> 1. Ethernet p.28 2. RS485 p.28 3. Wi-Fi 	<p>CHS 内置:</p> <ol style="list-style-type: none"> 1. 以太网 p.28 2. RS485 p.28 3. Wi-Fi 	<p>CHT 内建:</p> <ol style="list-style-type: none"> 1. 乙太網路 p.28 2. RS485 p.28 3. Wi-Fi
---	---	--	---

PL Opcjonalne	ES Opcional	CHS 选配	CHT 選配
	<p>PL ZigBee dla monitoringu ES ZigBee para monitorizar CHS 用于监控的ZigBee CHT 用於監控的ZigBee</p>		
	<p>PL ZigBee dla inteligentnej energii ES ZigBee para Smart Energy CHS 用于智能能量管理的ZigBee CHT 用於智慧能源管理的ZigBee</p>		
	<p>PL GSM Plug-in ES Plug-in GSM CHS GSM plug-in CHT Scheda GSM</p>		

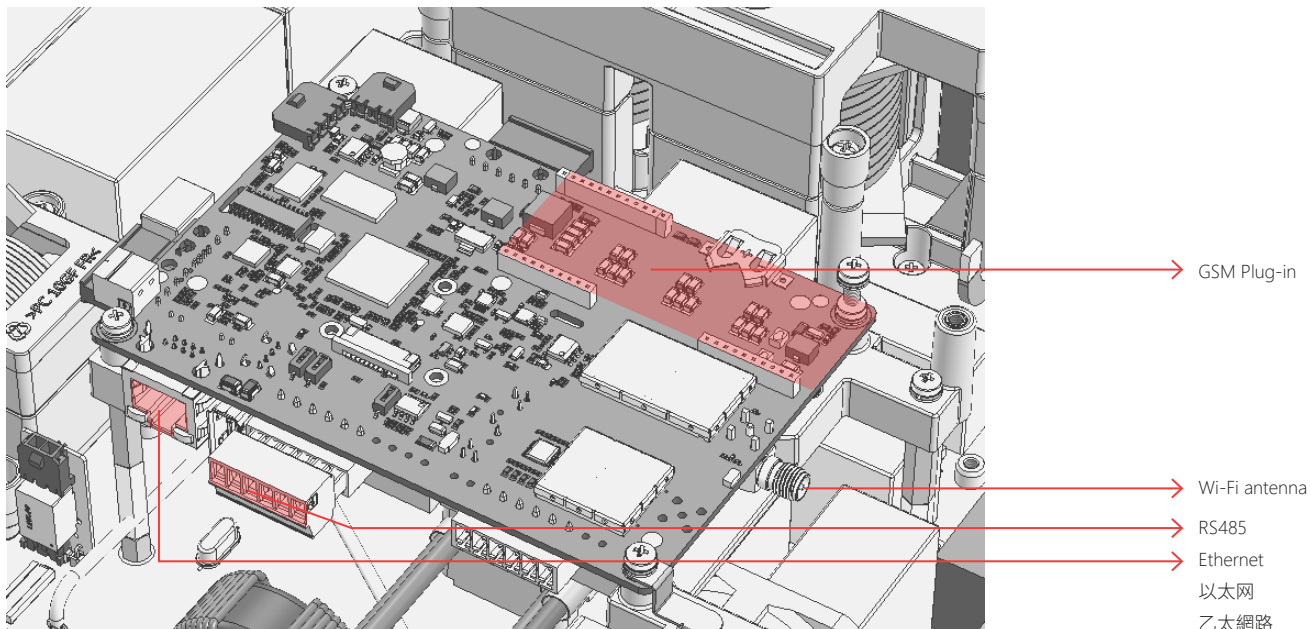

- PI** Rozwiązywanie problemów
- ES** Para resolución de problemas
- CHS** 排解故障
- CHT** 故障排除



- PI** Informacje o zastosowaniu: opcje komunikacji
- ES** Nota de aplicación: Opciones de comunicación
- CHS** 应用备注: 通信选项
- CHT** 應用備註: 通訊選項



6

PL USTANAWIANIE POŁĄCZENIA ETHERNET (LAN)

ES CREAR UNA CONEXIÓN ETHERNET (LAN)

CHS 创建以太网 (LAN) 连接

CHT 創建乙太網路 (LAN) 連接

1 2 3 4

1

2

3

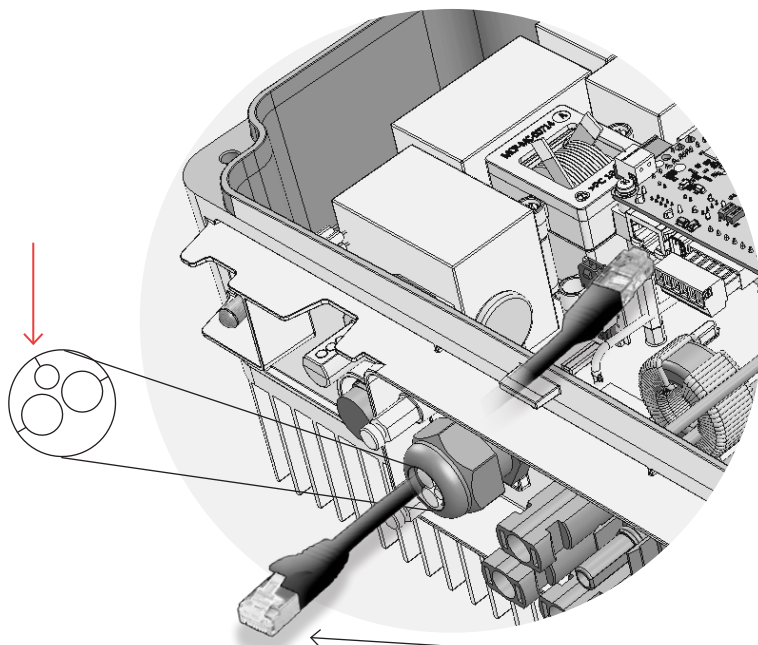
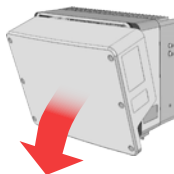

PI Router ethernetowy

ES Router Ethernet

CHS 以太网由器

CHT 以乙太網路路由器

PL

Styk RJ 45	Kolor przewodu ¹		T568B T568A
	T568B	T568A	Sygnal 100Base-TX
1	Biały/pomarańczowy	Biały/zielony	Transmit+
2	pomarańczowy	zielony	Transmit-
3	Biały/zielony	Biały/pomarańczowy	Receive+
4	Niebieski	Niebieski	Reserved
5	Biały/niebieski	Biały/niebieski	Reserved
6	zielony	pomarańczowy	Received-
7	Biały/brązowy	Biały/brązowy	Reserved
8	brązowy	brązowy	Reserved

ES

RJ45 Pin #	Color del cable ¹		T568B T568A Señal
	T568B	T568A	100Base-TX
1	Blanco/Naranja	Blanco/Verde	Transmitir+
2	Naranja	Verde	Transmitir-
3	Blanco/Verde	Blanco/Naranja	Recibir+
4	Azul	Azul	Reservado
5	Blanco/Azul	Blanco/Azul	Reservado
6	Verde	Naranja	Recibir-
7	Blanco/Marrón	Blanco/Marrón	Reservado
8	Marrón	Marrón	Reservado

CHS

RJ45引 脚#	电线颜色 ¹		T568B T568A
	T568B	T568A	100Base-发送信号
1	白色/橙色	白色/绿色	发送+
2	橙色	绿色	发送-
3	白色/绿色	白色/橙色	接收+
4	蓝色	蓝色	保留
5	白色/蓝色	白色/蓝色	保留
6	绿色	橙色	接收-
7	白色/棕色	白色/棕色	保留
8	棕色	棕色	保留

CHT

RJ45引 脚#	電線顏色 ¹		T568B T568A
	T568B	T568A	100Base-發送信號
1	白色/橙色	白色/綠色	發送+
2	橙色	綠色	發送-
3	白色/綠色	白色/橙色	接收+
4	藍色	藍色	保留
5	白色/藍色	白色/藍色	保留
6	綠色	橙色	接收-
7	白色/棕色	白色/棕色	保留
8	棕色	棕色	保留

PL ¹ Połączenie falownika nie obsługuje zmiany biegunowości RX/TX. Obsługa krosowych kabli ethernetowych zależy od możliwości przełączania

ES ¹ La conexión del inversor no es compatible con cambio de polaridad de RX/TX. La compatibilidad con cables Ethernet cruzados depende de las capacidades del switch

CHS ¹ 逆变器连接不支持接收/发送极性更改。是否支持交叉以太网电缆取决于集线器能力

CHT ¹ 逆變器連接不支持接收/發送極性更改。是否支援交叉乙太網路電纜取決於集線器能力

7

PL USTANAWIANIE POŁĄCZENIA Z MAGISTRALĄ RS485

ES CREAR UNA CONEXIÓN DE BUS RS485

CHS 创建RS485总线连接

CHT 建立RS485匯流排連接

1 2

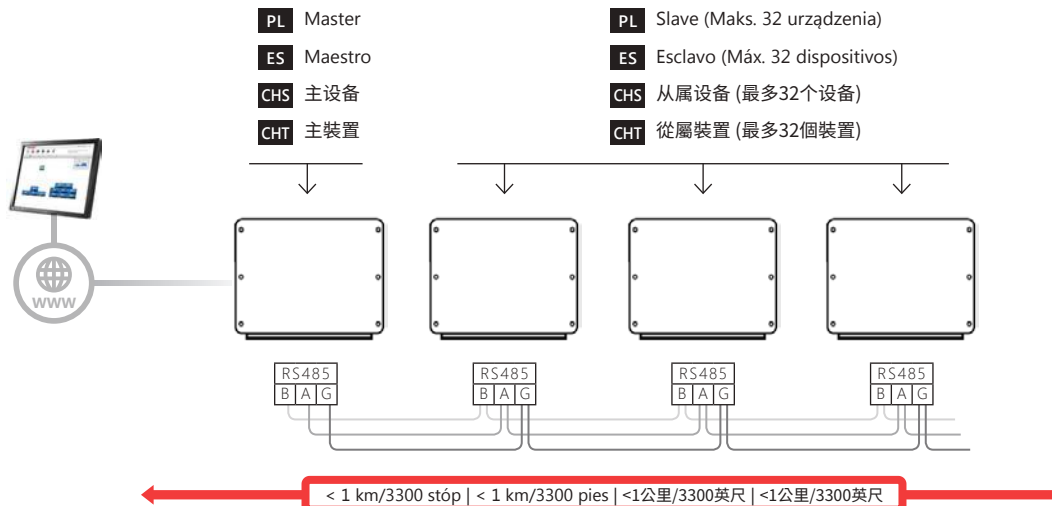
**PL**

Min. 3-żyłowa skrętka ekranowana (można użyć kabla 4-żyłowego) Średnica przewodu: 0,2-1 mm² / 24-18 AWG (można użyć kabla CAT5)

ES

Mín. cable apantallado de 3 pares de cables trenzados (se puede usar un cable de 4 pares de cables trenzados) Sección transversal del cable: 0,2-1 mm² / 24 -18 AWG (se puede usar un cable CAT5)

CHS

最低3线屏蔽双绞线(可使用4线电缆) 电线横截面: 0.2-1平方毫米/24-18美国线规(可使用CAT5电缆)

CHT

最低3線遮罩雙絞線(可使用4線電纜) 電線橫截面: 0.2-1平方毫米/24-18美國線規(可使用CAT5電纜)

- PL** Rozłączyć pierwsze i ostatnie urządzenie: Przesunąć w górę przełącznik SW1 DIP (lewy przełącznik)
- ES** Terminar el bus en el primero y último dispositivos: Mover el interruptor DIP SW1 hacia arriba (interruptor izquierdo)
- CHS** 终止第一个和最后一个设备: 上移SW1 DIP开关 (左开关)
- CHT** 終止第一個和最後一個裝置: 上移SW1 DIP開關 (左開關)

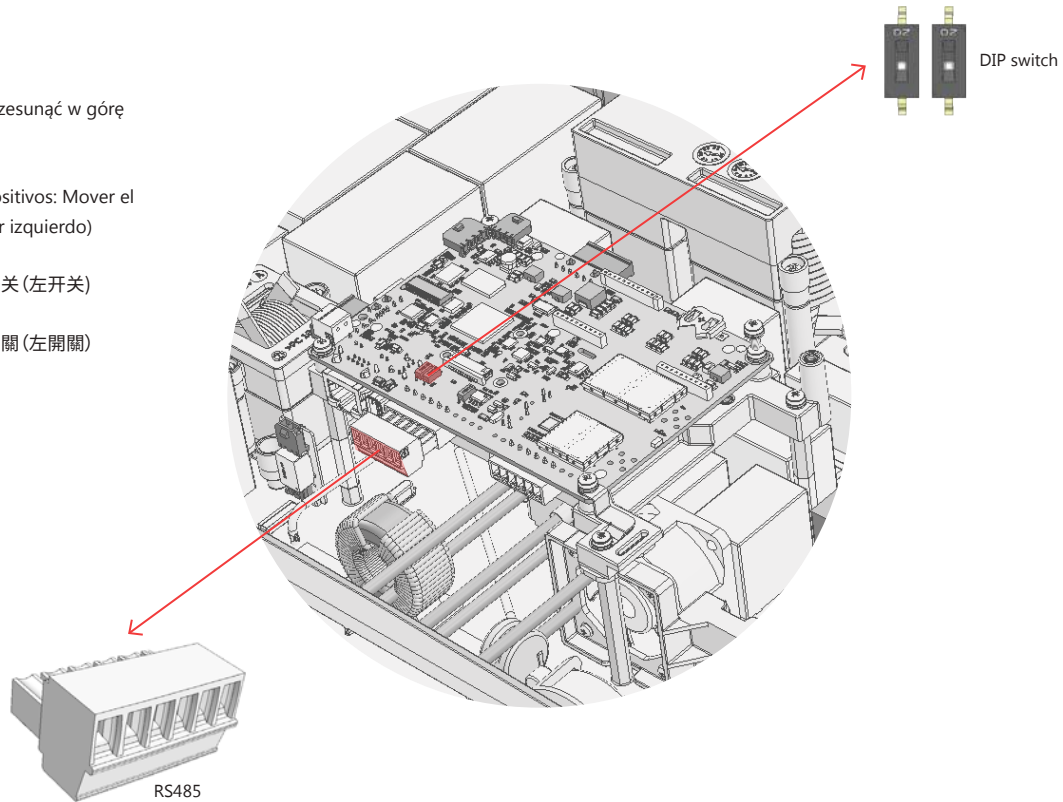

8

- PL PIERWSZA INSTALACJA SETAPP
- ES PRIMERA INSTALACIÓN SETAPP
- CHS 首次使用SETAPP安裝
- CHT 首次使用SETAPP安裝

1 — 2

**PL Login:**

1. Otwórz SetApp i postępuj zgodnie z instrukcjami
2. Zaloguj się przy pomocy swojej nazwy użytkownika i hasła do monitorowania

ES Login:

1. Abrir SetApp y seguir las instrucciones
2. Acceder con el usuario y contraseña del monitoring

CHS 登录:

1. 打开setapp并按照指令操作
2. 使用您监控平台的用户名和密码登录

CHT 登入:

1. 打開SetApp並按照說明步驟操作
2. 使用您的監控平台帳號及密碼登入

9

PL AKTYWACJA
 ES ACTIVANDO
 CHS 激活
 CHT 激活

1 — 2

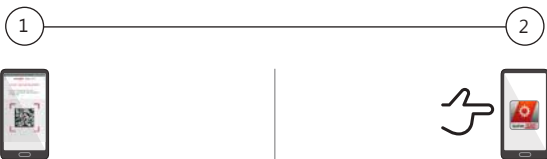

- PL** Zeskanuj kod QR falownika; dla magistrali RS485, najpierw wyszukaj master
- ES** Escanear el código QR del inversor; en caso de bus RS485, escanear primero el Maestro
- CHS** 扫描二维码; 对于RS485总线连接的逆变器, 请先扫描主逆变器
- CHT** 掃描逆變器QR Code; 如果有其他RS485之系統, 請先掃描主逆變器

- PL** Postępuj zgodnie z instrukcjami SetApp
- ES** Seguir las instrucciones de la SetApp
- CHS** 按照SetApp指令操作
- CHT** 按照SetApp說明步驟操作



- PL** SetApp tworzy połączenie Wi-Fi z falownikiem
- ES** SetApp establece una conexión Wi-Fi con el inversor
- CHS** SetApp通过WiFi与逆变器建立连接
- CHT** SetApp與逆變器通過Wi-Fi連接

10

EN URUCHOMIENIE INSTALACJI

FR PUESTA EN MARCHA

CHS 调试安装

CHT 調試安裝

1 2 3 4



- PL** Ustaw kraj i język
- ES** Fijar País e Idioma
- CHS** 设置国家代码与语言
- CHT** 設定國家及語言



- PL** Sparuj optymalizatory mocy
- ES** Emparejar los optimizadores
- CHS** 对优化器进行配对
- CHT** 配對功率優化器

- PL** Ustaw komunikację z platformą monitorowania i innymi falownikami
- ES** Establecer comunicación con el portal de monitorización y con los otros inversores onduleurs
- CHS** 建立与监控平台以及其他逆变器的通讯
- CHT** 建立與監控平台及其他逆變器之通訊

- PL** Ustaw wszystkie pozostałe parametry
- ES** Fijar los demás parametros
- CHS** 设置其他参数
- CHT** 設定其他參數

11

- PL PRZEGLĄDANIE STATUSU SYSTEMU
- ES VISUALIZACIÓN ESTADO DEL SISTEMA
- CHS 查看系统状态
- CHT 查看系統狀態

i

- PL Ustaw status ekranu
- ES Pantalla Estado SetApp
- CHS SetApp状态界面
- CHT SetApp狀態介面

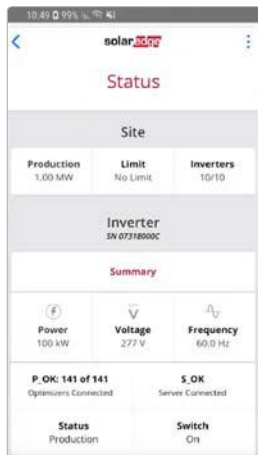

- PL Platforma monitorowania
- ES Portal de Monitorización
- CHS 监控平台
- CHT 監控系統

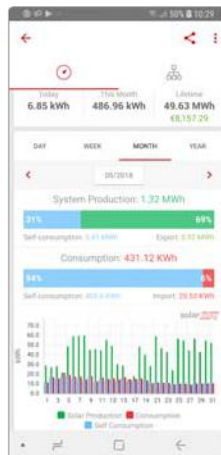

- PL Wskazania LED
- ES Indicaciones LED
- CHS LED指示
- CHR LED指示











PT LEGENDA

TH คำอธิบายสัญลักษณ์

SE FÖRKLARING

CZ LEGENDA

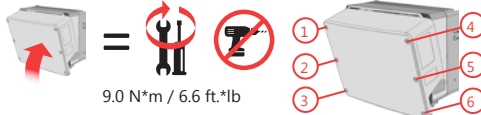
TR GÖSTERGELER

 <p>PT NOTA TH หมายเหตุ SE OBS CZ POZNÁMKA TR NOT</p>	 <p>PT Não cortar os conectores dos cabos TH อย่าตัดหัวต่อสาย SE Klipp inte av kontaktarna CZ Kably konektorů nestříhejte TR Kablo bağlantılarını kesmeyiniz.</p>	 <p>PT 1. Desligar chave de segurança (posição OFF/0) 2. Desligar chave CC 3. Abrir os seis parafusos da tampa</p> <p>TH 1. ตั้งสวิตช์เปิด/ปิดให้เป็น ปิด (0) 2. ตั้งสวิตช์เซฟตี้ให้เป็น ปิด 3. เบ็ดน็อตยึดฝาหกดตัว</p> <p>SE 1. Slå PÅ/AV till läget AV (0) 2. Vrid säkerhetsbrytaren till AV 3. Skruva upp de sex lockskruvarna</p> <p>CZ 1. Dejte vypínač ON/OFF do polohy OFF (0) 2. Dejte bezpečnostní vypínač do polohy OFF 3. Otevřete kryt uvolněním 6 šroubů</p> <p>TR 1. Kapatmak için AÇ/KAPA Anahtarını kapatınız (0) 2. Güvenlik Anahtarını KAPALI konuma getiriniz 3. Kapak Civatarlarını Açınız</p>
 <p>PT Ligar/Desligar disjuntor CA do inversor TH เปิด/ปิดสวิตช์ไฟฟ้ากระแสสลับแผงจอร์หลัก</p> <p>SE Slå PÅ/AV på huvudkretskortets AC-brytare</p> <p>CZ Zapnout/vypnout hlavní vypínač střídavého obvodu</p> <p>TR Ana devre AC anahtarı AÇ/KAPA</p>	 <p>PT Interruptor ON/OFF do Inversor: 0=OFF; 1=ON; P=pareamento/configuração TH สวิตช์เปิด/ปิดอินเวอร์เตอร์: 0=ปิด; 1=เปิด; P=จับคู่/โปรแกรม SE Växelriktarens strömbrytare: 0=AV; 1=PÅ; P=Pairing/program CZ Vypínač střídače ON/OFF: 0=OFF; 1=ON P=Párování/Program TR Evirici AÇ/KAPA Anahtarı 0=KAPA; 1=AÇ</p>	
 <p>PT Valor do Torque TH ค่าทอร์ค SE Vridmomentvärde CZ Hodnota kroutícího momentu TR Tork değeri</p>	 <p>PT Chave CC (na Caixa CC opcional) TH สวิตช์เซฟตี้ (เฉพาะสำหรับอินเวอร์เตอร์ที่มีชุดความปลอดภัยกระแสตรงเท่านั้น) SE Säkerhetsbrytare (på ev. tillvald DC-säkerhetsenhet) CZ Bezpečnostní vypínač (na volitelné DC Safety Unit) TR Güvenlik Anahtarı (opsiyonel DC Güvenlik Birimi)</p>	 <p>9.0 N*m / 6.6 ft.*lb</p>
 <p>PT LEDs TH LED SE lysdioder CZ LEDky TR LED'ler</p>		<p>PT Aperte os Seis Parafusos da Tampa TH เบ็ดน็อตยึดฝาหกดตัว SE Skruva åt de sex lockskruvarna CZ Připevněte kryt 6 šrouby TR Kapak civatarlarını kapatınız</p>

1

PT INSTALANDO OS OTIMIZADORES DE POTÊNCIA

TH การติดตั้งพาวเวอร์ออปติไมเซอร์

SE INSTALLERA EFFEKTOPTIMERARE

CZ INSTALACE VÝKONOVÝCH OPTIMIZÉRŮ

TR GÜÇ OPTİMİZÖRLERİNİN KURULUMU

1 2 3 4 5

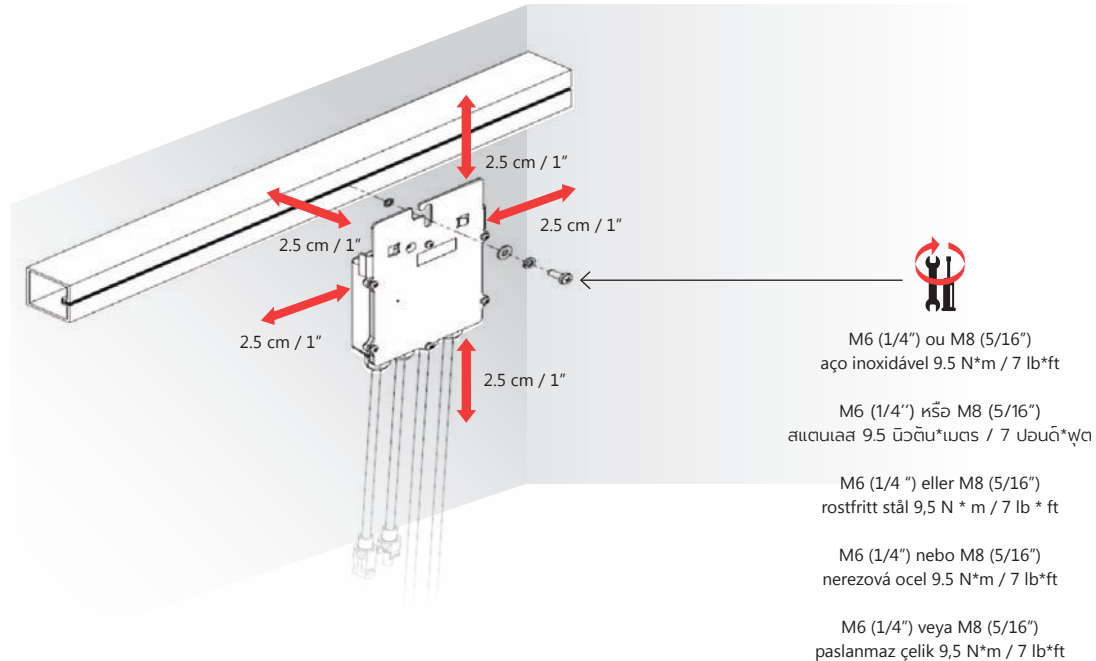

1

1 2 3 4 5

PT OPÇÃO A **SE** ALTERNATIV A **TR** A SEÇENEĞİ
TH ตัวเลือก A **CZ** MOŽNOST A

PT Remova os QR-Codes
TH ลอกสติ๊กเกอร์ออก
SE Ta bort dekalerna
CZ Odlepte nálepky
TR Yapışkanları çıkarınız

PT Escanear a folha com QR-Codes
TH สแกนแผ่นสติ๊กเกอร์
SE Skanna dekalarket
CZ Naskenujte štítek s nálepkami
TR Yapışkanlı kısmı tarayınız

PT Enviar folha com QR-Codes ao suporte técnico SolarEdge
TH ส่งอีเมลไปยังฝ่ายสนับสนุน SolarEdge
SE E-posta till SolarEdge support
CZ Pošlete e-mail tech. podpoře SolarEdge
TR Taramayı SolarEdge destek birimine email olarak gönderiniz



<http://www.solaredge.com/files/pdfs/physical-layout-template.pdf>

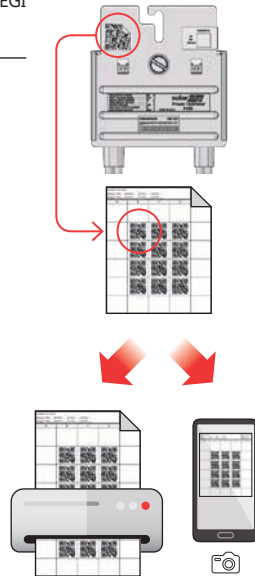

support@solaredge.com

PT OPÇÃO B **SE** ALTERNATIV B **TR** B SEÇENEĞİ
TH ตัวเลือก B **CZ** MOŽNOST B

PT Escanear QR-Codes com app Site Mapper
TH สแกนสติ๊กเกอร์โดยใช้ตัวทำแผนที่ไซต์
SE Skanna dekalerna med appen SolarEdge site mapper
CZ Naskenujte nálepky pomocí aplikace Mapper
TR Yapışkanları SolarEdge sitesi eşleyicisi kullanarak tarayınız

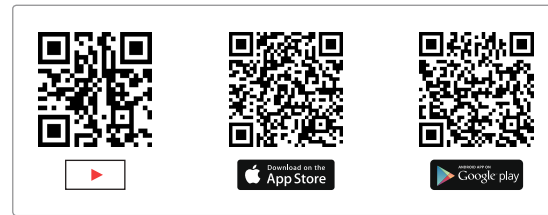

PT Complete o registro do sistema e o layout físico na plataforma de monitoramento
TH ลงทะเบียนบนไซต์และกำหนดทางกายภาพในระบบ ตรวจสอบติดตามให้เสร็จสมบูรณ์
SE Färdigställ anläggningens registrering och fysiska layout i monitoreringsportalen
CZ Dokončete registraci instalace a fyzické rozvržení v monitorovací platformě
TR İşleme platformunda site kaydını ve fiziksel düzeni tamamlayınız



1

1 2 3 4 5

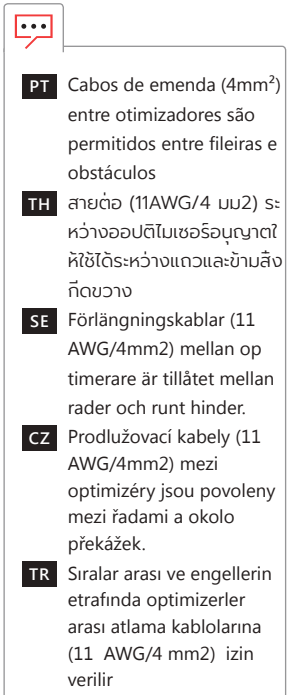
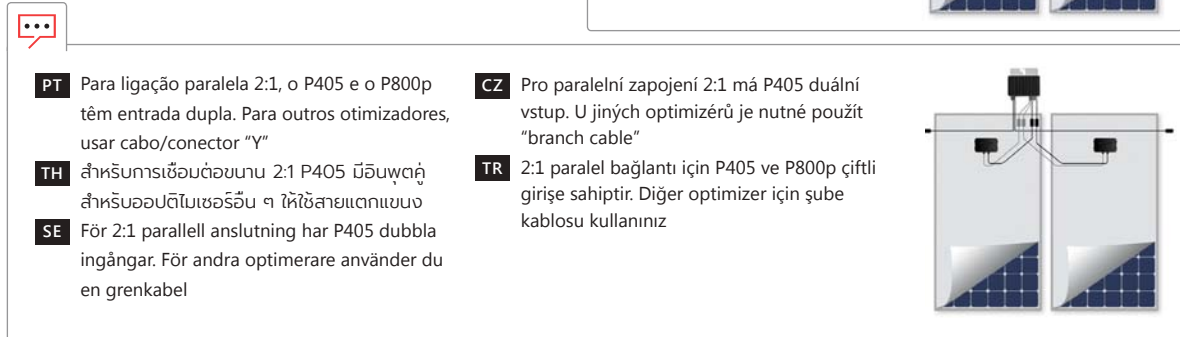
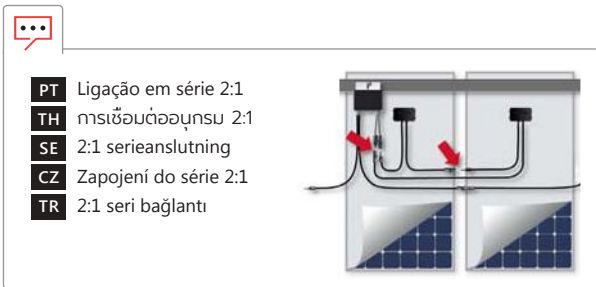
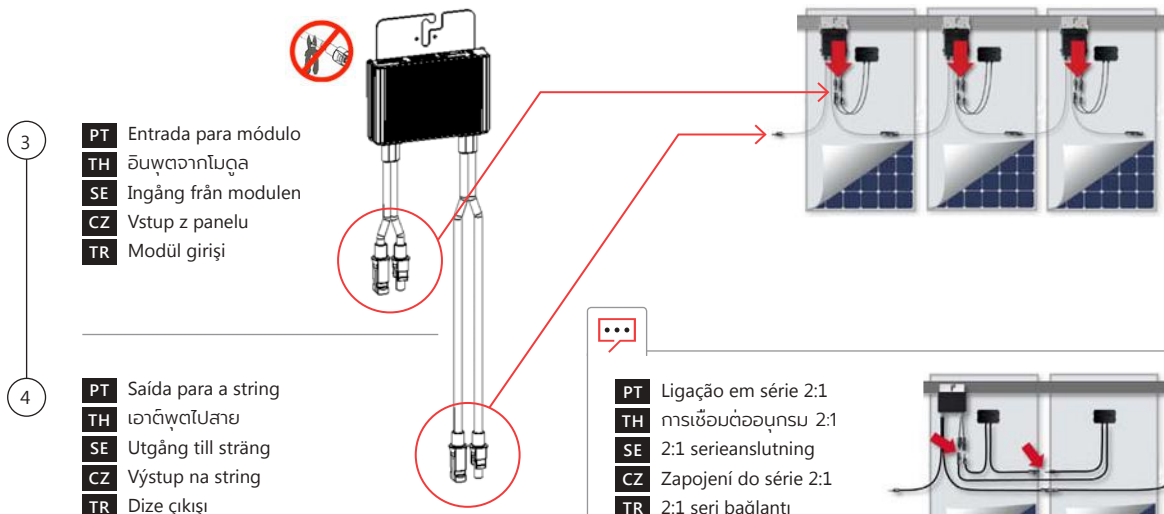

1

1 2 3 4 5

PT Verificar polaridade e medir tensão de cada string; confirmar 1V por otimizador

TH ให้ตรวจสอบขั้วสายและวัดแรงดันไฟฟ้าของแต่ละสายเพื่อตรวจสอบความถูกต้องควรมี 1V ต่อออปติไมเซอร์

SE Kontrollera strängspolariteten och mät spänningen i varje sträng för att verifiera $1\pm 0,1V$ per optimerare

CZ Zkontrolujte polaritu stringu a ověřte, že napětí každého stringu odpovídá $1\pm 0,1V$ na optimizér

TR Dize polaritesini kontrol ediniz ve her optimizier için $1\pm 0, 1V$ olduğundan emin olmak için her dizinin gerilimini ölçünüz

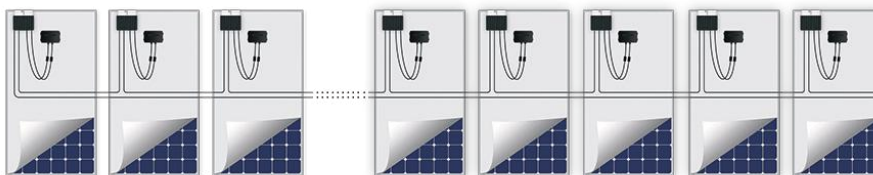

- PT** Exemplo: 16 optimizadores = ~16V
TH ตัวอย่าง: 16 ออปติไมเซอร์ = ~16V
SE Exempel: 16 effektoptimerare = ~ 16V
CZ Příklad: 16 optimizérů = ~16V
TR Örnek: 16 optimizier = ~16 V

2

- PT INSTALANDO O INVERSOR
 TH การติดตั้งอินเวอร์เตอร์
 SE INSTALLERA VÄXELRIKTAREN
 CZ INSTALACE STRÍDAČE
 TR EVIRICI KURULUMU

1 2 3 4

1 2 3 4

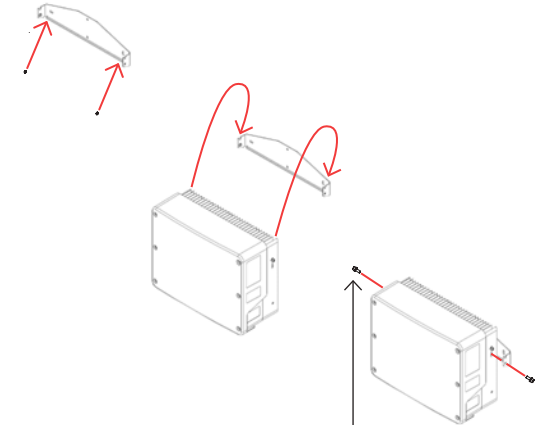
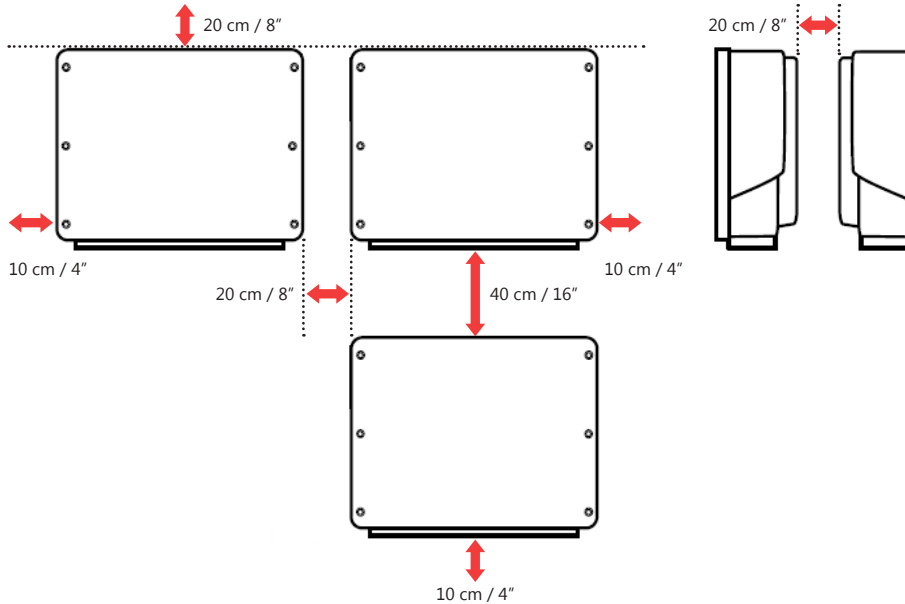

4.0 N*m / 2.9 lb.*ft.

3

- PT** CONECTAR OS FIOS AO INVERSOR
- TH** การเชื่อมสตริงกับอินเวอร์เตอร์
- SE** ANSLUTNING AV STRÅNGARNA TILL VÄXELRIKTAREN
- CZ** PŘIPOJOVÁNÍ STRINGŮ KE STRÍDAČI
- TR** DİZELERİN EVİRİCİYE BAĞLANMASI

1 2

1

- PT** 1-3 pares MC4, dependendo do modelo
- TH** คู่ MC4 1-3 ตัว ขึ้นกับรุ่น
- SE** 1-3 MC4 par, modellberoende
- CZ** 1-3 páry MC4, podle modelu
- TR** 1-3 MC4 çiftleri, model bağımlı



- PT** Para ligar mais strings em paralelo, use string-box externa ou "cabo Y"
- TH** สำหรับต่อสตริงในแนวขนานเพิ่มเติมให้ใช้กล่องรวมสายด้านนอกหรือสายแยกแขนง
- SE** För ytterligare strängar parallellkopplade använd extern kopplingsbox eller grenkablar
- CZ** Pro dodatečné paralelní stringy použijte externí sdružovací box nebo "branch cable"
- TR** Paralelde ekstra dizi kullanılacaksa, harici toplama kutusu veya şube kablosu kullanın

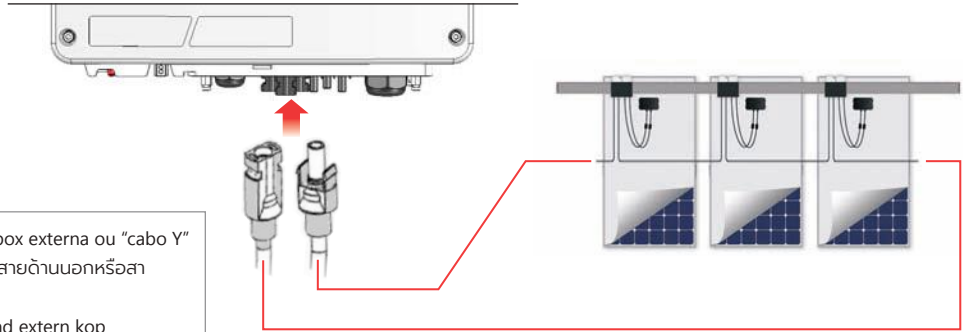

2

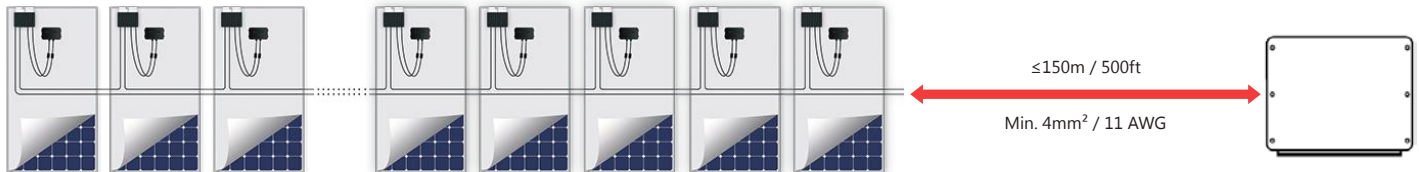

4

- PT** CONECTAR O AC AO INVERSOR
TH การเชื่อมไฟกระแสสลับกับอินเวอร์เตอร์
SE ANSLUTNING AV AC TILL VÄXELRIKTAREN
CZ PŘIPOJOVÁNÍ AC STRANY STŘÍDAČE
TR AC'NIN EVIRICIYE BAĞLANMASI

1 2 3

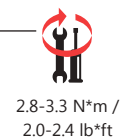
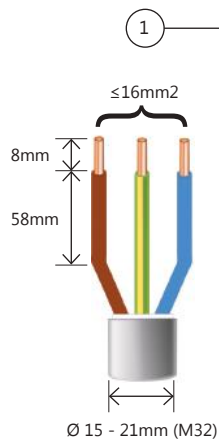

- PT** Ligar primeiro o condutor de equipotencialização.....
- TH** ให้ต่อ PE ก่อน.....
- SE** Anslut PE först.....
- CZ** Nejdříve připojte PE.....
- TR** Öncelikle PE bağlantısını yapınız.....

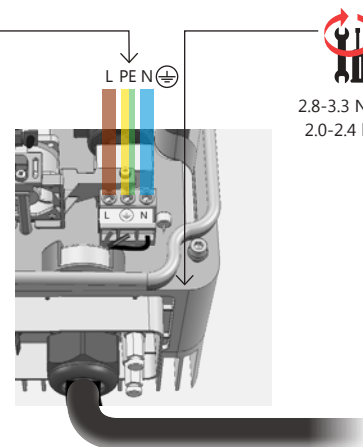

5

PT CONFIGURANDO A COMUNICAÇÃO

TH การจัดเตรียมการสื่อสาร



SE STÄLL IN KOMMUNIKATION

CZ NASTAVENÍ KOMUNIKACE

TR HABERLEŞME KURULUMU

i

<p>PT Embutido:</p> <ol style="list-style-type: none"> 1. Ethernet p. 2. RS485 p. 3. Wi-Fi 	<p>TH ติดในตัว:</p> <ol style="list-style-type: none"> 1. อีเทอร์เน็ต p. 2. RS485 p. 3. Wi-Fi 	<p>SE Inbyggd:</p> <ol style="list-style-type: none"> 1. Ethernet p. 2. RS485 p. 3. Wi-Fi 	<p>CZ Vestavěno:</p> <ol style="list-style-type: none"> 1. Ethernet p. 2. RS485 p. 3. Wi-Fi 	<p>TR Dahili:</p> <ol style="list-style-type: none"> 1. Ethernet p. 2. RS485 p. 3. Wi-Fi
--	---	---	---	--

PT Opcional	TH เป็นตัวเลือก	ES Tillval	CZ Volitelné	TR Opsiyonel
	<p>PT ZigBee para Monitoramento</p> <p>TH ชิปสำหรับระบบติดตามการทำงาน</p> <p>SE ZigBee för monitoreringsportal</p> <p>CZ ZigBee pro monitoring</p> <p>TR İzleme için Zigbee</p>			
	<p>PT ZigBee para Smart Energy</p> <p>TH ชิปสำหรับระบบพลังงานอัจฉริยะ</p> <p>SE ZigBee för Smart Hem</p> <p>CZ ZigBee pro Smart Energy</p> <p>TR Akıllı Enerji için Zigbee</p>			
	<p>PT Modem GSM</p> <p>TH แอร์การ์ด</p> <p>SE GSM-kort</p> <p>CZ Mobilní modem</p> <p>TR GSM Modem</p>			

5

i

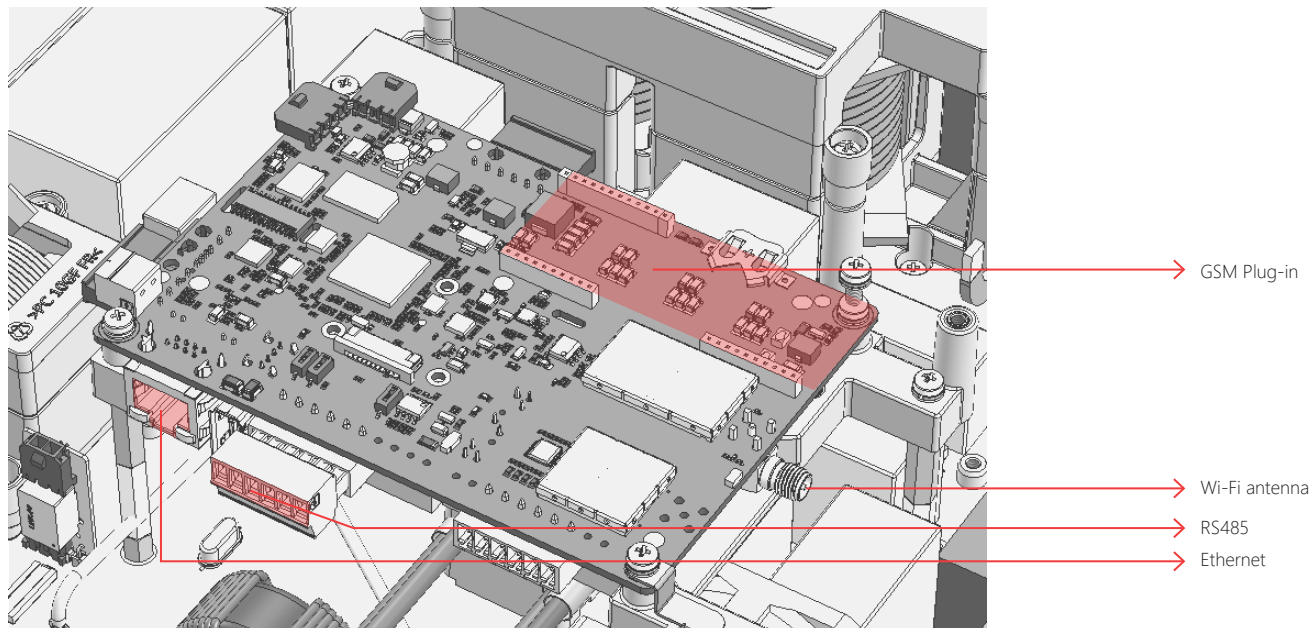

PT Para resolução de problemas
TH สำหรับการแก้ไขปัญหา
SE För felsökning
CZ Pro řešení problémů
TR Sorun giderme



PT Nota de Aplicação: Opções de Comunicação
TH หมายเหตุแอปพลิเคชัน: ตัวเลือกการสื่อสาร
SE Tillämpningsanteckning: Kommunikationsalternativ
CZ Návod k aplikaci: Komunikační možnosti
TR Uygulama notu: Haberleşme Seçenekleri



6

- PT CRIANDO UMA CONEXÃO ETHERNET (LAN)
 TH การสร้างการเชื่อมต่ออีเทอร์เน็ต (LAN)
 SE SKAPA EN ETHERNET-ANSLUTNING (LAN)
 CZ VYTVOŘENÍ ETHERNETOVÉHO (LAN) PŘIPOJENÍ
 TR ETHERNET (LAN) BAĞLANTISI OLUŞTURMA

1 2 3 4

1

2

3

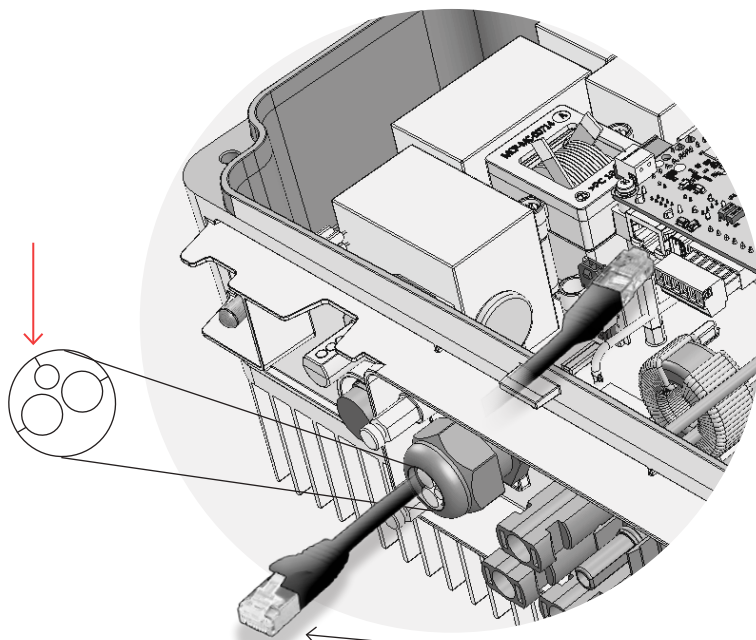
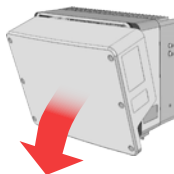

- PT Router Ethernet
 TH เราเตอร์อีเทอร์เน็ต
 SE Ethernet-router
 CZ Ethernetový směrovač
 TR Ethernet Yönlendirici

PT

Pino RJ45 #	Cor do fio ¹		Sinal 10Base-TX Sinal 100Base-TX
	T568B	T568A	
1	Branco/Laranja	Branco/Verde	Transmissor+
2	Laranja	Verde	Transmissor-
3	Branco/Verde	Branco/Laranja	Receptor+
4	Azul	Azul	Reservado
5	Branco/Azul	Branco/Azul	Reservado
6	Verde	Laranja	Receptor-
7	Branco/Marrom	Branco/Marrom	Reservado
8	Marrom	Marrom	Reservado

TH

ທາ RJ45 #	Kleur van de draden ¹		10Base-TX ລັດຖະບານ 100Base-TX ລັດຖະບານ
	T568B	T568A	
1	ຫວ/ສັນ	ຫວ/ເຜັຍວ	Transmit+
2	ສັນ	ເຜັຍວ	Transmit-
3	ຫວ/ເຜັຍວ	ຫວ/ສັນ	Receive+
4	ຟ້າເຈັນ	ຟ້າເຈັນ	Reserved
5	ຫວ/ຟ້າເຈັນ	ຫວ/ຟ້າເຈັນ	Reserved
6	ເຜັຍວ	ສັນ	Received-
7	ຫວ/ຟ້າຕາ	ຫວ/ຟ້າຕາ	Reserved
8	ຟ້າຕາ	ຟ້າຕາ	Reserved

SE

RJ45 Pin #	Kabelfärg ¹		10Base-TX Signal 100Base-TX Signal
	T568B	T568A	
1	Vit / Orange	Vit / Grön	Skicka+
2	Orange	Grön	Skicka-
3	Vit / Grön	Vit / Orange	Mottag+
4	Blå	Blå	Reserverad
5	Vit /Blå	Vit /Blå	Reserverad
6	Grön	Orange	Mottagen-
7	Vit /Brun	Vit /Brun	Reserverad
8	Brun	Brun	Reserverad

CZ

Pino RJ45 #	Barva drátu ¹		10Base-TX Signal 100Base-TX Signal
	T568B	T568A	
1	Bílý/Oranžový	Bílý/Zelený	Transmit+
2	Oranžový	Zelený	Transmit-
3	Bílý/Zelený	Bílý/Oranžový	Receive+
4	Modrý	Modrý	Reserved
5	Bílý/Modrý	Bílý/Modrý	Reserved
6	Zelený	Oranžový	Received-
7	Bílý/Hnědý	Bílý/Hnědý	Reserved
8	Hnědý	Hnědý	Reserved

TR

RJ45 girişleri #	Tel rengi ¹		10Baz-TX Sinyal 100Baz-TX Sinyal
	T568B	T568A	
1	Beyaz/Turuncu	Beyaz/Yeşil	İlet+
2	Turuncu	Yeşil	İlet-
3	Beyaz/Yeşil	Beyaz/Turuncu	Al+
4	Mavi	Mavi	Rezerve
5	Beyaz/Mavi	Beyaz/Mavi	Ayrıldı
6	Yeşil	Turuncu	Alındı-
7	Beyaz/Kahverengi	Beyaz/Kahverengi	Rezerve
8	Kahverengi	Kahverengi	Rezerve

PT

¹A conexão do inversor não suporta inversão de polarizado RX/TX. O suporte a cabos 'crossover' depende do switch

TH

¹การเชื่อมต่ออินเวอร์เตอร์ไม่รองรับการเปลี่ยนขั้ว RX/TX การรองรับสายไขว้เทอร์เน็ตขึ้นอยู่กับความสามารถของสวิตช์

SE

¹Växelriktarens anslutning stöder inte Rx/Tx polaritet. Stödjande Ethernet-kabelövergångar beror på switchfunktionerna

CZ

¹Připojení střídače nepodporuje změnu polarity RX/TX. Podpora křížených ethernetových kabelů závisí na možnostech přepínače

TR

¹Evirici bağlantısı RX/TX polarite değişikliğini desteklemiyor. Ethernet kablo atlamalarının desteklenmesi anahtar niteliğine bağlıdır

7

PT CRIANDO UMA CONEXÃO COM BARRAMENTO RS485

TH การสร้างการเชื่อมต่อบัส RS485

SE SKAPA EN RS485-BUSSANSLUTNING

CZ PŘIPOJENÍ NA SBĚRNICI RS485

TR RS485 VERI YOLU BAĞLANTISI KURUN

1 2

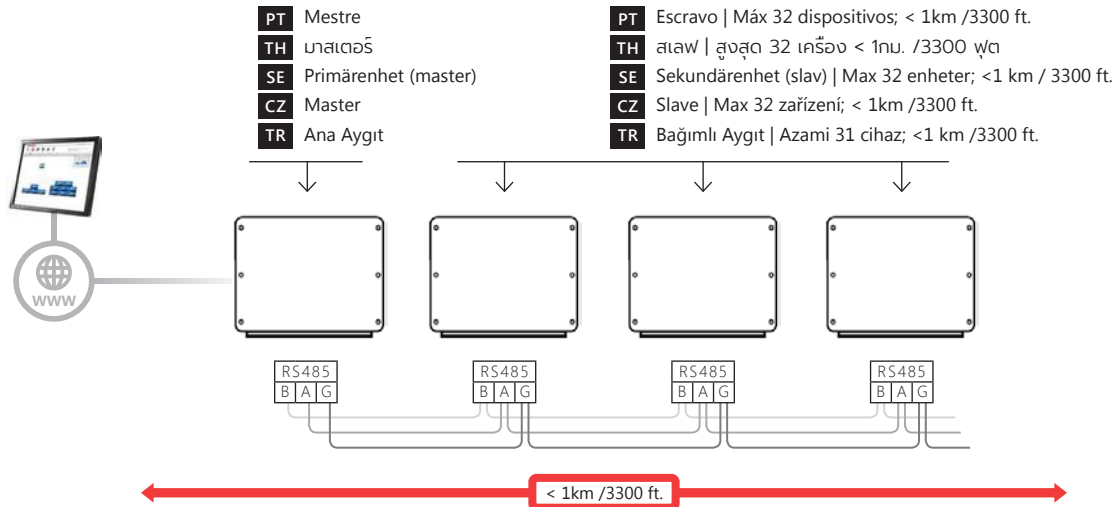

PT Mín. de 3 fios, par trançado blindado (pode ser usado cabo de 4 fios). Seção transversal do fio: 0,2-1 mm² / 24-18 AWG (pode ser usado um cabo CAT5)

TH ขั้นต่ำ สายคู่บิดเกลียว 3 สายแบบมีชีลด์ (อาจใช้สายแบบ 4 สายได้) จุดตัดสาย: 0.2-1 มม.² / 24-18 AWG (อาจใช้สาย CAT5 ได้)

SE Min. 3-tråds- avskärmat tvinnat par (en 4-trådig kabel kan användas) Ledartvärsnitt: 0,2-1 mm² / 24-18 AWG (en CAT5-kabel kan användas)

CZ Kroucená dvoulinka - min. 3 stíněné páry (může být použit kabel se 4 páry) Průřez vodiče: 0,2-1 mm² / 24-18 AWG (může být použit kabel CAT5)

TR Asgari 3 telli çift bükümlü ekranlı kablo (4 telli kablo kullanılabilir) Tel kesiti: 0,2-1 mm² / 24-18 AWG (CAT5 kablo kullanılabilir)

- PT** Ligar o terminador do primeiro e do último dispositivo: Mova o DIP switch SW1 (switch esquerdo)
- TH** ปิดเครื่องแรกและเครื่องสุดท้าย: เลื่อนสวิตช์ SW1 DIP ขึ้น (สวิตช์ทางซ้าย)
- SE** Avsluta första och sista enheter: Flytta upp SW1 DIP-omkopplare (vänster brytare)
- CZ** Ukončete první a poslední zařízení: SW1 DIP přepínač dejte nahoru (levý přepínač)
- TR** İlk ve son cihazları sonlandır: SW1 DIP anahtarını yukarı kaldırın (sol anahtar)

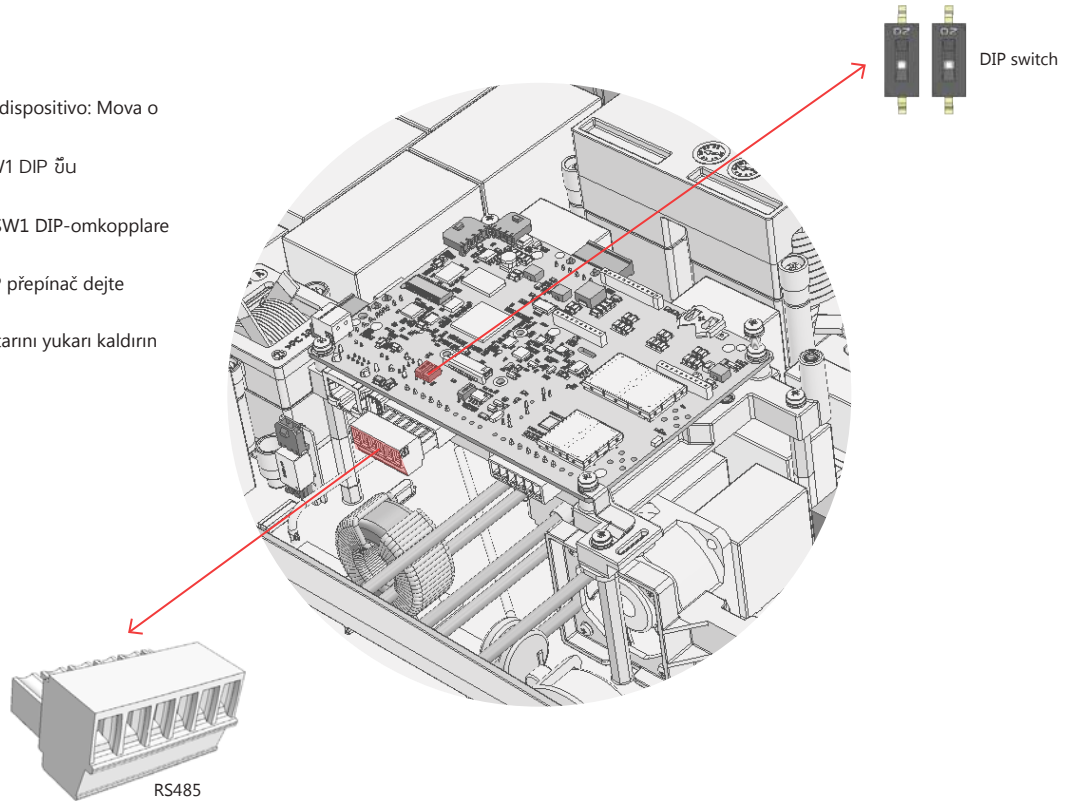

8

- PT 1.^a INSTALAÇÃO COM SETAPP
- TH การติดตั้ง SETAPP ครึ่งแรก
- SE 1:A DRIFTSÄTTNING MED SETAPP
- CZ PRVOTNÍ INSTALACE SETAPP
- TR İLK DEFA SETAPP KURULUMU

1 — 2

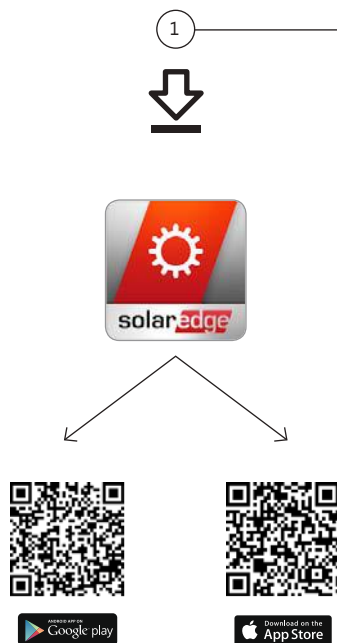
**PT Login:**

1. Abrir SetApp e seguir instruções
2. Logar com seu usuário e senha do Monitoramento

TH ลงบันทึกเข้า

1. เปิด SetApp และทำตามวิธีการใช้งาน
2. ลงบันทึกเข้าในระบบติดตามด้วยชื่อผู้ใช้และรหัสผ่าน

SE Login:

1. Öppna SetApp och följ instruktionerna
2. Logga in med samma anv.uppg. som för monitoreringsportal

CZ Přihlášení:

1. Otevřete SetApp a následujte instrukce
2. Přihlašte se pomocí jména a hesla pro monitoring

TR Kayıt:

1. SetApp'ı açın ve yönlendirmeleri takip edin
2. Abrir SetApp e seguir instruções

9

- PT ATIVAÇÃO
 TH เปิดการใช้งาน
 SE AKTIVERING
 CZ AKTIVACE
 TR AKTIVE OLUYOR

1 — 2



1



- PT RS-485, escanear primeiro o mestre.
 TH สแกนอินเวอร์เตอร์รหัส QR; สำหรับบัส RS485 ให้สแกนตัวหลักก่อน
 SE Skanna växelriktarens QR-kod; för RS485-bus, skanna masterenheten först
 CZ Naskenujte QR kód střídače; pro sběrnici RS485 naskenujte nejdrive master
 TR RS485 veriyolu, öncelikle ana bilgisayardan tara

2



- PT Seguir instruções do SetApp
 TH ทำตามวิธีการใช้ SetApp
 SE Följ anvisningar i SetApp
 CZ Následujte instrukce SetApp
 TR SetApp yönlendirmelerini takip et



- PT SetApp cria uma conexão wi-fi com o inversor
 TH SetApp สามารถสร้างการเชื่อมต่อไวไฟกับอินเวอร์เตอร์
 SE SetApp upprättar en wifi-anslutning med växelriktaren
 CZ SetApp vytvoří Wi-Fi spojení s měničem
 TR SetApp evirici ile bir kablosuz ağ kuruyor

10

- PT** PÔR A INSTALAÇÃO EM FUNCIONAMENTO
- TH** การทดสอบการใช้งานของระบบ
- SE** DRIFTSÄTTNING
- CZ** SPUŠTĚNÍ INSTALACE
- TR** KURULUM GERÇEKLEŞTİRİLMESİ

1 2 3 4



1

2

3

4

- PT** Seleccione o País e Idioma
- TH** ตั้งค่าประเทศและภาษา
- SE** Välj land och språk
- CZ** Nastavte zemi a jazyk
- TR** Ülkeyi ve dili ayarla



- PT** Emparelhar os Otimizadores
- TH** จับคู่อินเวอร์เตอร์
- SE** Para optimerarna
- CZ** Napárujte výkonové optimizéry
- TR** Optimizerleri eşleştir

- PT** Ajustar comunicação com a Plata
forma de Monitoramento e com os
outros inversores
- TH** ตั้งค่าการสื่อสารกับระบบติดตามและอิน
เวอร์เตอร์อื่น
- SE** Ställ kommunikation för monitore
ringsportal och ev andra växelriktare
- CZ** Nastavte komunikaci k monitorovací
platformě a dalším měničům
- TR** İzleme sistemi ve diğer eviricilerle ile
haberleşmeyi kur

- PT** Ajustar todos os outros parâmetros
- TH** ตั้งค่าพารามิเตอร์อื่นทั้งหมด
- SE** Ställ ev. andra inställningar
- CZ** Nastavte všechny ostatní parametry
- TR** Diğer ayarları kur

11

- PT VISUALIZANDO STATUS DO SISTEMA
- TH ดูสถานะการทำงาน
- SE SE SYSTEMSTATUS
- CZ ZOBRAZENÍ STAVU SYSTÉMU
- TR SİSTEM DURUMUNU GÖRÜNTELEME

i

- PT Tela de Status do SetApp
- TH จอสถานะ SetApp
- SE SetApp statusskärm
- CZ Stavová obrazovka SetApp
- TR SetApp Durum ekranı

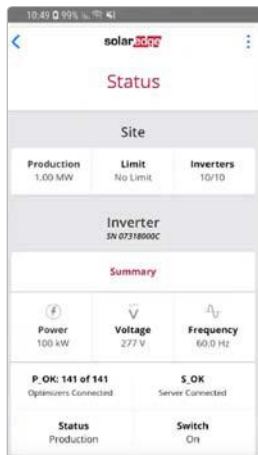

- PT Plataforma de Monitoramento
- TH ระบบติดตามการทำงาน
- SE SetApp statusskärm
- CZ Stavová obrazovka SetApp
- TR SetApp Durum ekranı

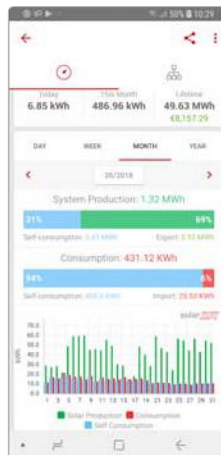

- PT Indicações do LEDs
- TH สัญลักษณ์ LED
- SE LED-indikering
- CZ Indikace LED
- TR LED göstergeleri



